

68  
December  
1988

elektor **INDIA**

163  
Rs. 8.00

# electronics

THE PRACTICAL MAGAZINE WITH THE PROFESSIONAL APPROACH



First ever interview given to  
an Electronics Magazine by  
**Mr. Manu Chhabria**



- Optoelectronics
- $\mu P$  - based multimeter
- Bus interface for LCD screens

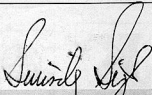

**Publisher :** C.R. Chandarana  
**Editor :** Surendra Iyer  
**Technical Adviser :** Ashok Dongre  
**Circulation :** J. Dhas  
**Advertising :** B.M. Mehta  
**Production :** C.N. Mithagari

**Address :**  
ELEKTOR ELECTRONICS PVT. LTD.  
52, C Proctor Road, Bombay-400 007 INDIA  
Telex: (011) 76661 ELEK IN

**Overseas editions :**

**Elektor Electronics**  
1, Harlequin Avenue,  
Great West Road, Brentford TW8, SEW U.K.  
**Editor :** Len Seymour

**Pultron Publicações Técnicas Ltda**  
Av Ipiranga 1100, 9º andar CEP 01040 Sao Paulo - Brazil  
**Editor :** Juliano Bersali

**Elektor sari**  
Route Nationale, Le Saut; B.P. 53  
952270 Bailletul - France  
**Editors :** D R S Meyer;  
G C P Radersdorf

**Elektor Verlag GmbH**  
Susterfeld-Str. 25 100 Aachen - West Germany  
**Editor :** E J A Krempelsauer

**Elektor EPE**  
Karaissaki 14 16573 Voulo - Athens - Greece  
**Editor :** E Xanthoulis

**Elektuur B.V.**  
Peter Treckpoelstraat 2.4  
6191 VK Beek - the Netherlands  
**Editor :** P E L Kerssemakers

**Ferreira & Bento Lda**  
R.D. Estefania, 32, Pº 1000 Lisboa - Portugal  
**Editor :** Jorge Goncalves

**Ingelek S.A.**  
Plaza Republica Ecuador 2.28016 Madrid-Spain  
**Editor :** A M Ferrer

**In Part:**  
Kedhorn Holdings PTY Ltd Cnr Fox Valley Road &  
Kingle Street Wahroonga NSW 2076 - Australia  
**Editor :** Roger Harrison

**Electronic Press AB**  
Box 63  
182 11 Danderyd - Sweden  
**Editor :** Bill Cedrum

The Circuits are domestic use only. The submission of designs or articles implies permission to the publisher to alter and translate the text and design and to use the contents in other Elektor Publications and activities. The publishers cannot guarantee to return any material submitted to them. Material must be sent to the Holland address (given above). All drawings, photographs, printed circuit boards and articles published in elektor publications are copyright and may not be reproduced or imitated in whole or part without prior written permission of the publishers.

Patent protection may exist in respect of circuit devices, components etc. described in this magazine.

The publishers do not accept responsibility for failing to identify such patent or other protection.

# CONTENTS

## Editorial

Technology Transfer .....	12.07
---------------------------	-------

## Special Feature

The jumbo success of Chhabria (An Exclusive Interview) .....	12.10
Computer gurus for video teaching .....	12.14
Optoelectronics .....	12.43
A very intelligent computer terminal .....	12.46

## Audio & Hi-Fi

PROJECT: LFA 150 - a fat power amplifier (Part 1) .....	12.28
---	-------

## Computers

PROJECT: Bus interface for high-resolution liquid crystal screens (Part 1) .	12.48
--	-------

## Electronics

PROJECT: Portable MIDI keyboard .....	12.37
PROJECT: Harmonic enhancer .....	12.59

## General Interest

PROJECT: Infra-red remote control for stepper motors .....	12.24
DESIGN IDEA: Mains signalling .....	12.34
DESIGN IDEA: Fade asleep .....	12.27

## Radio & Television

DESIGN IDEA: A microprocessor-based intelligent multi-function test instrument .....	12.55
---	-------

## Information

Telecom news .....	12.18
Electronics news .....	12.19
New products .....	12.66

## Guide Lines

Classified ads .....	12.74
Index of advertisers .....	12.74



MEMBER

Printed at : Trupti Offset  
Bombay - 400 013  
Ph. 4923261, 4921354  
Copyright © 1988 Elektuur B.V.

# TECHNOLOGY TRANSFER

The Prime Minister, Mr. Rajiv Gandhi, has observed that import substitution is "one of the biggest mistakes" committed by our country. While distributing the Shanti Swarup Bhatnagar awards to outstanding scientists Mr. Gandhi regretted that we ended up substituting third or fourth generation but never reached the forefront while resorting to substitution.

Mr. Gandhi's statement may appear to be a sweeping generalisation but he is not wide off the mark. But, the blame for this lopsided result does not lie at the door step of scientists and technologists alone as often technology transfer decisions are based on political considerations. Examples of this kind are too many.

Telecommunication in the country is now saddled with half-a-dozen technologies with shifting stands taken at various times. The so-called Phased Manufacturing Programmes in electronics never crossed the phase of importing the kits and assembling them.

We had seen unsavoury experiences regarding the technology transfer for the National Silicon Facility. Indigenous technology finally got a chance in this respect. Again, we find a similar problem in technology transfer regarding the manufacture of 1.5 micron chips. Two public sector organisations are working at cross purposes.

Bharat Electronics Ltd. is embroiled in a controversy over its Talaja glass shells unit. The defence ministry desires BEL to give up its diversification into consumer electronics and concentrate on defence projects. To make colour glass shells, an investment of Rs. 95 crores is required. BEL entered into joint venture with Rashtriya Chemicals and Fertilisers Ltd. another public sector unit for its Talaja expansion programme. The government shot down RCF's entry and introduced Samtel, a private firm with the multinational Corning Glass. Government has been forced to re-examine the issue in the wake of widespread criticism.

It is thus clear that true technology transfer cannot take place unless vested interests give way to national interests.

## Front cover

A recently introduced IC makes a dream of many electrophonics enthusiasts come true: to build their own MIDI keyboard from a handful of components. The portability of the keyboard described in this issue makes it ideal for first-aid testing of MIDI equipment. Moreover, in conjunction with a microprocessor, it can be used for practising, composing, and editing musical pieces in places where a full-size keyboard would be cumbersome to use.

# INFRA-RED REMOTE CONTROL FOR STEPPER MOTORS

Many audio purists balk at the use of an electronic volume control, but would still like to upgrade a home-made preamplifier with remote control. This can be accomplished by using a good-quality potentiometer, a stepper motor, and the simple, yet versatile, infra-red transmitter and receiver described here.

One particularly interesting application of the proposed infra-red remote control system is the actuating of the volume potentiometer in a high-quality audio preamplifier, such as the one described last month. Basically, the potentiometer is operated by a small stepper motor, whose direction of travel is controlled by means of pulses emitted by a hand-held infra-red transmitter.

## Infra-red transmitter

The circuit diagram of this part of the remote control system is shown in Fig. 1. Simple data encoding is used to keep the cost of the circuit as low as possible. The direction of travel of the stepper motor fitted at the receiver side is determined by the width of the pulses supplied by two monostable multivibrators, MMV<sub>1</sub> (70  $\mu$ s) and MMV<sub>2</sub> (470  $\mu$ s). The pulse frequency, and hence the motor speed, is set with P<sub>1</sub> in oscillator N<sub>1</sub>-N<sub>2</sub>. Buttons S<sub>1</sub> and S<sub>2</sub> form the volume up/down controls because they determine whether MMV<sub>1</sub> or MMV<sub>2</sub> drives the output transistor, T<sub>1</sub>. The pulsating infra-red light beam is emitted by series-connected IREs D<sub>1</sub>-D<sub>2</sub>-D<sub>3</sub>.

## Receiver and motor driver

Photodiode D<sub>4</sub> in Fig. 2 was selected for optimum sensitivity in the part of the infra-red spectrum covered by the sender diodes (see also Ref. 1.) The photocurrent generated by the incident infra-red light is magnified and converted to a voltage by opamp A<sub>1</sub>, which drives detector A<sub>1</sub> via high-pass C<sub>5</sub>-R<sub>13</sub>. This filter serves to eliminate interference

caused by sunlight and hum superimposed on light by electric bulbs. The detection threshold of comparator A<sub>1</sub> is kept low at about 10 mV (R<sub>10</sub>-R<sub>12</sub>) to ensure adequate sensitivity. Feedback resistor R<sub>11</sub> provides the necessary hysteresis to prevent jitter and spurious step pulses being generated when A<sub>1</sub> toggles.

Each received pulse triggers both MMV<sub>3</sub> and MMV<sub>4</sub>, and is compared to reference pulses of 220  $\mu$ s supplied by MMV<sub>4</sub>. Received pulses are applied direct to the clock input of stepper motor driver ICs, whose DIR (direction) input is controlled by the output of MMV<sub>4</sub>. This makes the direction of travel of the stepper motor dependent on the length of the received pulses, relative to that of the reference pulses.

### Features:

- Infra-red remote control link with a range of up to 8 metres.
- Forward/reverse control of stepper motors.
- Adjustable motor speed.
- Drives a variety of 2-stator, unipolar, motors.
- Maximum drive capability: 4 A per phase.
- Supply voltages:
  - receiver logic: 9.5-18 VDC;
  - stepper motor: max. 18 VDC;
  - transmitter: 9 V PP3 battery.
- Simple, low-cost design.

Although the stepper motor driver Type SAA1027 (SGS/Philips Components) is capable of supplying stator currents of up to 500 mA, power drivers (T<sub>1</sub>-T<sub>4</sub>) are added to prevent excessive dissipation, and to allow the use of motors that require more current. The flyback diodes in the power stage should be fast-recovery types (IN493x series, or BYV27). The use of the ubiquitous 1N4001 is not recommended unless the total stator current is known to remain well under 1 A. Power resistors R<sub>16</sub> and R<sub>17</sub> may be used to achieve a rudimentary kind of current drive of the stator windings in the motor — more on this under 'The power supply'.

Provision has been made for manual operation, at the receiver, of the volume control. This is achieved by T<sub>2</sub>-R<sub>14</sub> automatically interrupting the base current for the driver stage in the SAA1027 when no pulses have been received for about 0.1 s. Series transistor T<sub>2</sub> then interrupts the hold torque for the motor, so that the potentiometer spindle can be operated manually. This type of control guarantees low overall dissipation because there is no quiescent hold current. Certain motors do require a continuous hold current, however. These can still used with the present circuit simply by omitting T<sub>2</sub> and fitting a wire link between the connections provided for its collector and emitter terminals.

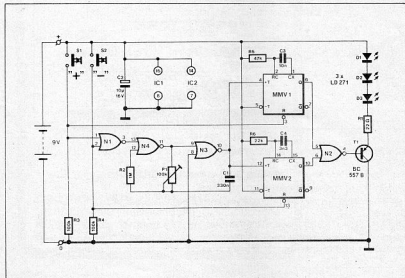

Fig. 1. Circuit diagram of the hand-held infra-red transmitter.



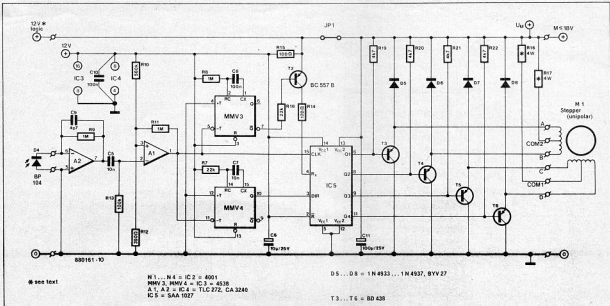

Fig. 2. Circuit diagram of the infra-red receiver, pulse decoder and stepper motor driver.

### The power supply

The IR transmitter is powered by a 9 V PP3 battery. An on/off switch is not required because the quiescent current consumption of the circuit is negligible at a few nano-amperes. This rises to a few milli-amperes when either of the two buttons is pressed. The actual current consumption then depends on the setting of P1.

The type of supply required for the receiver depends mainly on the environment in which this circuit is used. The logic circuitry can operate from a supply

voltage between 9.5 V and 18 V. It will be clear that the supply for the motor is laid out in accordance with the type used. A 12 V motor is ideal because it allows powering the driver stage and the logic circuitry from a common supply, connected to terminals U<sub>01</sub> and ground (fit jumper JP1). The logic supply is decoupled with the aid of R<sub>15</sub>-C<sub>6</sub>. Fit wire links in positions R<sub>16</sub> and R<sub>17</sub> when the motor used requires voltage drive. Many stepper motors are 5 V types. Where a relatively powerful type is used, it is recommended to dimension the motor supply for 5 V (connect to U<sub>01</sub>

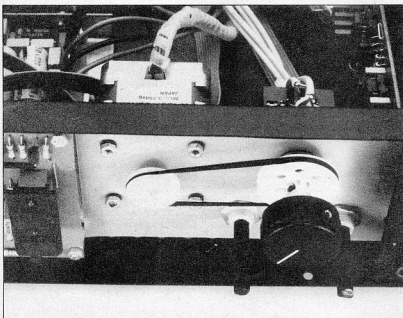

Motorized volume control built into the high-quality preamplifier described last month.

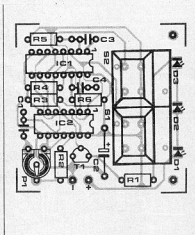

Fig. 3. Printed circuit board for the transmitter. Together with a PP3 battery, it fits exactly in a Type 222 enclosure from Heddie.

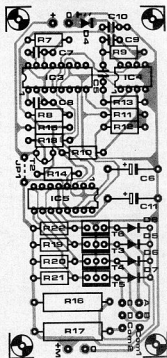
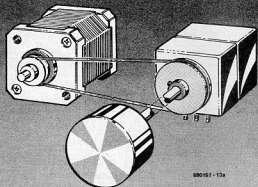
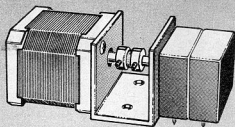

Fig. 4. Printed circuit board for the receiver.



880161 - 13a



880161 - 13b

Fig. 5. Two suggestions for coupling the stepper motor spindle to that of the potentiometer.

#### Parts list

##### Resistors ( $\pm 5\%$ ):

R1 = 22R  
 R2; R6; R9; R11 = 1M $\Omega$   
 R3; R4; R13 = 100K  
 R5 = 47K  
 R6; R7 = 22K  
 R10 = 560K  
 R12 = 390R  
 R14 = 120R  
 R15 = 100R  
 R16; R17 = 4 W resistor; value depends on stepper motor used.  
 R18 = 22K  
 R19... R22 incl. = 4K7  
 P1 = 100K preset H

##### Capacitors:

C1 = 330n  
 C2 = 10 $\mu$ ; 16 V  
 C3; C5; C7 = 10n  
 C4 = 3n3  
 C6 = 10 $\mu$ ; 25 V  
 C8; C10 = 100n  
 C9 = 4p7  
 C11 = 100 $\mu$ ; 25 V

##### Semiconductors:

D1; D2; D3 = LD271<sup>†</sup>  
 D4 = BP104<sup>†</sup>  
 D5... D8 incl. = 1N4933/4<sup>†</sup> / 5/6/7 or BYV27<sup>†</sup>  
 T1; T2 = BC557B  
 T3... T6 incl. = BD438  
 IC1; IC3 = 4538  
 IC2 = 4001  
 IC4 = TLC272 or CA3240  
 IC5 = SAA1027<sup>†</sup>

##### Miscellaneous:

S1; S2 = Digitast switch (ITW or ITT/Schadow).  
 3 off plastic reflectors<sup>†</sup> for D1-D3.  
 PCB Type 880161

and ground). Fit wire links for R16 and R17, but do not fit JP1 — connect the 12 V supply to terminals + and 0 (close to D<sub>4</sub> on the PCB). Where a relatively small stepper motor is used, R16 and R17 are dimensioned to reduce U<sub>M</sub> from 12 V to the voltage required. This is convenient because it allows the complete receiver plus motor driver to be powered from a single supply. Small, 200-step, 5 V motors used in disk drives are sometimes offered by surplus stores. These motors give excellent results with R16 = R17 = 39  $\Omega$ ; 4 W (stator current = 200 mA).

It should be noted that the circuit can only drive unipolar motors. These normally have 6 connecting wires, but there are also 5-wire types in which the centre taps of the two stator windings (COM1; COM2) have been connected internally.

## Constructional hints

Construction of the transmitter and receiver on the printed circuit boards shown in Figs. 3 and 4 should not cause problems. The transmitter is fitted in a hand-held ABS enclosure with integral battery compartment. The 3 IREDs are fitted with ready-made reflectors to increase the range of the transmitter. To prevent it seeing light from bulbs or fluorescent tubes fitted to the ceiling, the photodiode in the receiver should be mounted in a short tube whose inside is painted matt black. If the diode is fitted on to the front panel of the audio equipment, it should be connected to the receiver board by means of shielded wire. In some cases, it may be necessary to decrease the sensitivity of the receiver to prevent it being triggered by ambient light. This can be achieved by increasing the value of  $R_{12}$  to, say, 560  $\Omega$ .

The use of a stepper motor that draws more than about 1 A necessitates cooling of the power transistors in the receiver by clamping them together with the aid of 3 small, 2.5 mm thick, pieces of aluminium and a central M3 bolt. Figures 5a and 5b provide suggestions for coupling the stepper motor spindle to that of the potentiometer. Cog-wheel systems should not be used because they are damaged quite easily by the vibration of the stepper motor. A rubber or nylon belt as used in cassette recorders, or a strengthened O-ring, is perfect because it allows manual control of the potentiometer as discussed earlier.

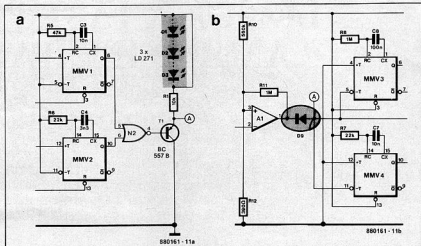

Fig. 6. Modifications to transmitter and receiver to enable manual volume control when the stepper motor and potentiometer spindles are coupled as shown in Fig. 5b.

The stepper motor and the volume potentiometer may also be secured on to a common U-shaped piece of aluminium as shown in Fig. 5b. In this arrangement, the spindles are coupled direct. Manual control is still possible, however, when the transmitter is duplicated and fitted close to the receiver. The modifications to the transmitter and the receiver to achieve local control are shown in Figs. 6a and 6b. In the transmitter, the (shaded) IREDs are replaced with a wire link,  $R_1$  is replaced with a 10 k $\Omega$  type, and the points marked A in the transmitter and receiver are interconnected.

Diode  $D_9$  is inserted between the comparator output and the trigger inputs of the monostables. Together with the  $T_1$  in the transmitter, it forms a wired-OR function. The 'local' volume up/down controls,  $S_1$  and  $S_2$ , are fitted on to the front panel of the equipment.

## References:

1. Long-range infra-red transceiver. *Elektronika*, December 1987. Contains a useful background to infra-red light communication.

## fade asleep

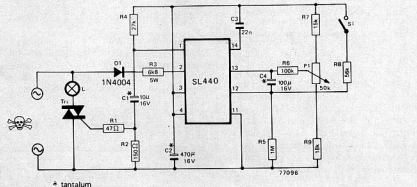

Some children have less difficulty falling asleep if the bedroom light is left on. However, this means that one of the parents has to go up after half an hour or so to turn the lights off – hopefully without waking the children up again . . . The circuit described here will fade out the lights very slowly, either completely off or to a preset minimum (night-light) level.

As long as  $S_1$  is closed the light(s) will burn at full brightness. As soon as  $S_1$  is opened, the lights start to fade out very gradually until they reach a certain level (preset by means of  $P_1$ ). The fade-out time is determined by the value of  $C_4$  and by the setting of  $P_1$ . As an example, if  $C_4 = 100 \mu$  and  $P_1$  is set at minimum it will take approximately half an hour for the lamp to fade out. If

desired,  $C_4$  can be increased; however, it is not advisable to go above about 470  $\mu$ . The circuit *must* be mounted in a well-insulated case, and  $P_1$  should be a potentiometer with a plastic spindle. The type of triac required will depend on the load, of course. It is advisable to select a type that is capable of handling a current of up to

$$I_L = 5 \frac{P_L}{U_M}$$

where  $P_L$  is the nominal 'wattage' of the lamp and  $U_M$  is the nominal mains voltage. A 'cold' filament draws a relatively heavy current!

(Plessey application)

# LFA-150: A FAST POWER AMPLIFIER (PART 1)

from a basic idea by A. Schmeets

This first of a two-part article describes the design of a power amplifier that makes use of very fast ring-emitter transistors and delivers up to 150 watts into 8 ohms. A feature of the design is the low negative-feedback factor.

Although commercial high-quality audio power amplifiers have made use of multiple-emitter and ring-emitter transistors for some time, these devices have not been easily obtainable for private purposes. That situation has changed, fortunately, and a number of importers can now supply them on a small-quantity basis.

Multiple-emitter transistors consist of a number of identical transistors connected in parallel on one chip. The ring-emitter transistor is a power transistor with a special chip structure for the base, collector and emitter regions. These transistors are the fastest and most linear devices for use in audio power amplifiers.

High-quality audio power amplifiers are still based on discrete designs, although good-quality power amplifier modules have become available over the past year or so. However, where absolute top quality is wanted, based on an unconventional design, there is no other way than the use of discrete transistors.

The present design hinges on low open-loop gain, which guarantees minimal transient-intermodulation (TIM) distortion and thus the best possible sound quality. The bandwidth is sufficiently large to ensure minimal phase shift over the entire audio range, which again aids the sound quality.

## Design philosophy

The design of an AF power amplifier can go two ways. The first uses a very high open-loop gain combined with a very large negative-feedback factor; the second, a low open-loop gain and a consequent smaller negative-feedback factor. Most audio power amplifiers belong to the first category, because in that design it is easy to achieve low harmonic distortion. However, that design also has a serious shortcoming. When the input signal is fairly large and of a frequency that lies outside the open-loop bandwidth of the amplifier, there is a

Power output (20 Hz-20 kHz; THD = 0,5%)	150 W into 8 ohms 200 W into 4 ohms
THD (1 kHz)	< 0.01% (1 W) < 0.01% (10 W) < 0.04% (100 W)
(20 Hz - 20 kHz)	< 0.025% (1 W)
Frequency response (1 W)	1 Hz - 1 MHz (unweighted)
Power bandwidth	1 Hz - 350 kHz (unweighted)
Phase error (20 Hz - 20 kHz)	< 5°
TIM (75 W; 50 Hz; 7 kHz; 4:1)	< 0.05%
Slew rate	> 50 V/μs (unweighted)
Open-loop bandwidth	10 kHz
Open-loop amplification	2,300
Output impedance	< 0.05 ohm
Input sensitivity	1.1 V r.m.s.
Signal-to-noise ratio	> 110 dB

likelihood, owing to the high open-loop gain, of some of the internal amplifier stages becoming saturated. This results in strong bursts of intermodulation that are clearly audible and sound like crossover distortion. Note that the audio signal variations are maximum around the zero crossing points, so that saturation is most likely about these points. These problems may be avoided by reducing the open-loop gain. This increases the open-loop bandwidth, so that the likelihood of the frequency of the input signal lying outside the open-loop bandwidth is much smaller. Of course, this also causes an increase in the total harmonic distortion (THD), but that is not really a serious problem. The

human ear is nowhere near as sensitive to THD as to TIM and crossover distortion. In other words, an amplifier with 0.3% THD and 0.003% TIM will in practice always sound better than one with 0.003% THD and 0.3% TIM. Apart from low open-loop gain, the various stages of a good-quality amplifier need to have a large bandwidth to ensure, if possible, an open-loop bandwidth greater than the audio range. It is, fortunately, possible to optimize both the bandwidth and the phase behaviour where necessary in the amplifier with the aid of lead-compensation (networks that locally increase the amplification above a given frequency). Another important aspect is the fre-

quency compensation that limits the open-loop bandwidth (the so-called lag-compensation). This compensation determines the slew rate of the amplifier and must, therefore, be applied as close to the input as possible to ensure that the input signal is limited before it is fed to the amplifier stages.

In many amplifiers, the negative-feedback factor for a.c. signals is different from that for d.c. signals, which is normally achieved with the aid of a capacitor. It is true that this puts less of an onus on the stability of the circuit, but it may give rise to problems, particularly since the capacitor often has such a large value that an electrolytic type (!) is used. With correct design and good temperature stability throughout the amplifier, there is no need for the two factors to be different.

### Practical considerations

Although the foregoing, on the face of it, would lead to a near-ideal design, there are some practical problems. To start with, it is difficult to achieve low THD and low TIM in the same design: in practice, a compromise has to be sought. In the present design, this is found in an open-loop amplification of 2,300 and an open-loop bandwidth of 10 kHz. The amplification is sufficient to achieve acceptable THD figures. The goal of an open-loop bandwidth of 20 kHz or more proved impossible to achieve, however, in spite of extensive lead-compensation. Furthermore, the stability requirements meant severe limiting of phase shifts and this proved only possible by restricting the open-loop bandwidth to around 10 kHz. It should be noted, of course, that this is still an outstanding bandwidth: most commercial amplifiers with a high open-loop amplification (100,000 to 1,000,000) have an open-loop bandwidth of 30 to 50 or 60 Hz!

The lag-compensating network, which determines the bandwidth, is located between the branches of the first differential amplifier. It would have been possible to locate it between the inputs of that amplifier, but that would have meant taking back the feedback to the input also. And that in turn would result in the amplification becoming dependent, partly at least, on the characteristics of the preceding preamplifier.

To make it possible for the amplifier to be DC-coupled throughout (to keep the a.c. and d.c. gains equal), a double FET was found necessary at the input: not an inexpensive solution, but one resulting in very good stability. It is true that the gain of a FET combination is on the low side, but in this particular design that does not matter.

The slew rate in the practical design is kept to 50 V/ $\mu$ s. Again, this is on the safe side, because in the prototypes slew rates of around 100 V/ $\mu$ s were attainable.

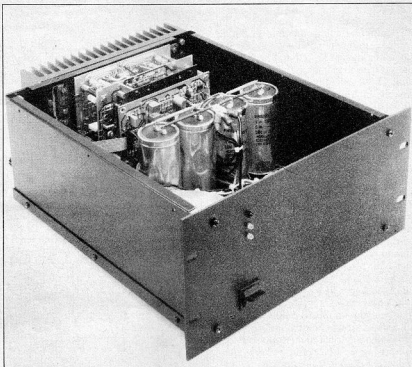

Fig. 1. General view of the LFA-150.

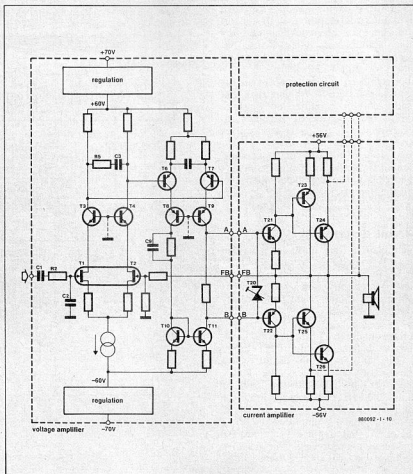

Fig. 2. Simplified circuit diagram of the LFA-150.

## The design

The basic design may be assessed from the simplified circuit diagram in Fig. 2. It is split into two parts: a voltage amplifier and a current amplifier. The input of the voltage amplifier is formed by the dual FET already mentioned. The cascode circuit connected to the drains of the FETs not only enables the drain-source voltage of the FETs to be kept at a reasonable value, but also, more importantly, to eliminate to a large extent the internal drain-gate capacitance of the FETs, resulting in a substantial bandwidth.

The first differential amplifier is followed by another, which is, however, constructed from discrete transistors and, moreover, is provided with a current mirror,  $T_{10}$  and  $T_{11}$ . The current mirror serves to provide a signal at B that is in phase with that at A.

Network  $R_5$ - $C_1$  provides lag compensation, while  $C_8$  and  $C_9$  provide lead compensation.

The current amplifier consists of a quiescent-current control around  $T_{20}$  and a symmetrical dual output stage, comprising a driver and two parallel-connected output transistors.

Noteworthy in the output stage is that the output transistors are not connected as emitter followers but in a so-called compound configuration. In this, a sort of darlington is created which, due to a large amount of internal negative-feedback, combines very low distortion with a low output impedance.

The stabilized power supply to the voltage amplifier is 4 V higher than that to the current amplifier, so that the voltage drop across the output transistors remains small, even at maximum drive.

Finally, the protection circuit serves to monitor the setting of the quiescent current level, the loudspeaker impedance, and the output current.

## Circuit description

Each of the four unshaded parts in Fig. 3 is housed on a separate PCB. At the left is the voltage amplifier; beside it the current amplifier and protection circuit; and at the top right the auxiliary power supply.

**Voltage amplifier.** The input signal is applied to differential amplifier  $T_1$ - $T_2$  via  $C_1$  (the only capacitor in the entire signal path) and low-pass filter  $R_2$ - $C_2$ . The filter has a cut-off frequency of about 200 kHz. It serves to limit the bandwidth, and thus the slew rate, before the signal is amplified.

The differential amplifier is a dual FET housed in a metal case. The negative feedback voltage is applied to the gate of  $T_2$ .

Transistors  $T_3$  and  $T_4$  and the FETs

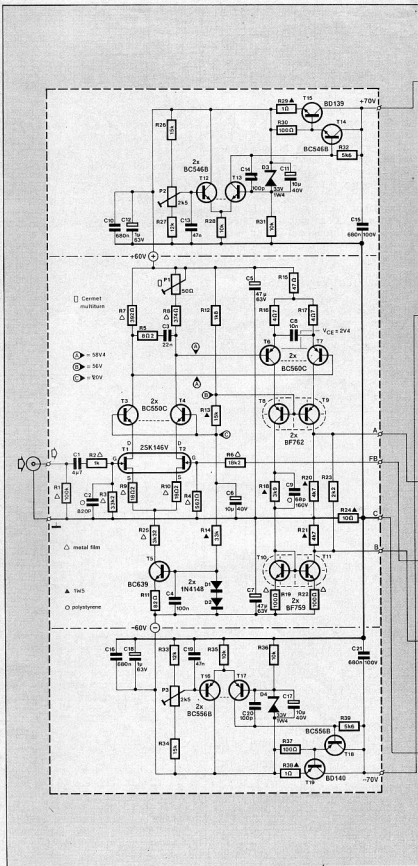

Fig. 3. Circuit diagram of the LFA-150.

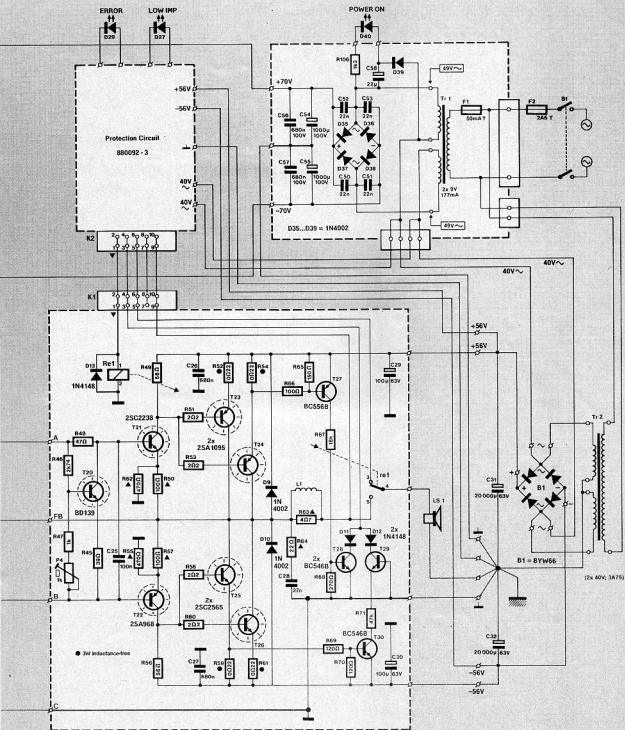
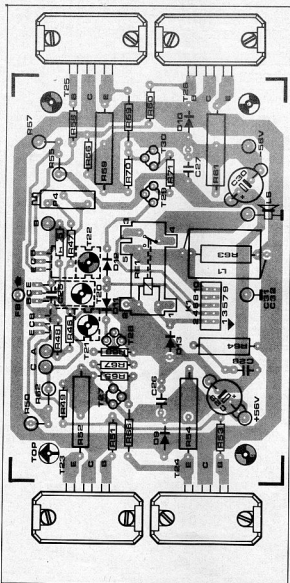
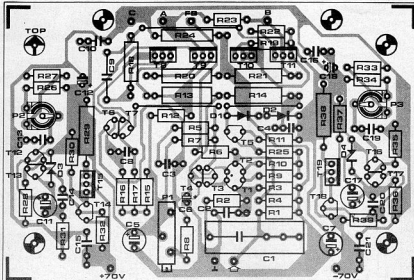

Fig. 4. PCB for the voltage amplifier.



Parts list

VOLTAGE AMPLIFIER BOARD

Resistors:

- R1 = 100K<sup>+</sup>
- R2 = 1K0<sup>+</sup>
- R3 = 3K2<sup>+</sup>
- R4 = 562R<sup>+</sup>
- Rn = 8R2
- R6 = 18K2<sup>+</sup>
- R7 = 392R<sup>+</sup>
- R8 = 374R<sup>+</sup>
- R9, R10 = 18R2<sup>+</sup>
- R11 = 82R
- R12 = 1K8
- R13 = 15K; 1.5 W
- R14 = 33K; 1.5 W type
- R15 = 47R
- R16, R17 = 4R7
- R18 = 3K9; 1.5 W
- R19, R22 = 100R<sup>+</sup>
- R20, R21 = 4K7; 1.5 W
- R23 = 2K2
- R24 = 10R; 1.5 W
- R25 = 3K32<sup>+</sup>
- R28, R34 = 15K
- R27, R33 = 12K
- R28, R31, R35, R36 = 10K
- R29, R38 = 1R0; 1.5 W
- R30, R37 = 100R
- R32, R39 = 5K6
- P1 = 50R multiterm preset (Cermet)
- P2, P3 = 2K5 preset H

\* Metal film resistor

Capacitors:

- C1 = 4μ7; MKT
- C2 = 820p polystyrene/styroxflex
- C3 = 22n
- C4 = 100n
- C5, C7 = 47μ; 63 V
- C6, C11, C17 = 10μ; 40 V
- C8 = 10n
- C9 = 68p; 160 V; polystyrene/styroxflex
- C10, C16 = 680n
- C12, C18 = 1μ0; 63 V
- C13, C19 = 47n
- C14, C20 = 100p
- C15, C21 = 680n; 100 V

Semiconductors:

- D1, D2 = 1N4148
- D3, D4 = 33V; 1.4 W zener diode
- T1, T2 = 2SK146V
- T3, T4 = BC550C
- T5 = BC639
- T6, T7 = BC560C
- T8, T9 = BF762
- T10, T11 = BF759
- T12...T14 incl. = 8C546B
- T15 = BD139
- T16...T18 incl. = 8C556B
- T19 = BD140

Miscellaneous:

- PCB Type 880092-1



**Parts list****CURRENT AMPLIFIER BOARD****Resistors:**

R45 = 39R  
 R46 = 2K74 +  
 R47 = 1K0 +  
 R48 = 47R  
 R49; R56 = 56R  
 R50; R57 = 100R; 1.5 W  
 R51; R53; R59; R60 = 2R2  
 R52; R54; R55; R61 = 0R22 non-inductive resistor  
 R58; R62 = 470R; 1.5 W  
 R63 = 4R7; 1.5 W  
 R64 = 22R; 1.5 W  
 R65 = 150R  
 R66 = 100R  
 R67 = 18K  
 R68 = 270R  
 R69; R70 = 120R  
 R71 = 47K  
 P4 = 1K0 multturn preset (Cermet)

## \* Metal film resistor

**Capacitors:**

C26 = 100n  
 C26; C27 = 680n  
 C28 = 27n; 250 V  
 C29; C30 = 100 $\mu$ F  
 C31; C32 = 20,000 $\mu$ F; 63 V (can-type capacitor, not on PCB)

**Semiconductors:**

B1 = BYW66 (not on PCB)  
 D9; D10 = 1N4002  
 D11; D12; D13 = 1N4148  
 T20 = BD139  
 T21 = 2SC2238  
 T22 = 2SA968 T23; T24 = 2SA1095  
 T25; T26 = 2SC2565  
 T27 = BC556B  
 T28; T29; T30 = BC546B

**Miscellaneous:**

K1 = 10-way straight header.  
 L1 = 12 turns enamelled copper wire, dia. 1.5 mm; internal diameter approx. 15 mm.  
 R61 = V23127-80006-A201 (24 V change-over relay; Siemens)  
 PCB 880092-2.

form a cascode circuit: T<sub>1</sub> and T<sub>4</sub> maintain the drain potential, derived from divider R<sub>12</sub>-R<sub>13</sub>-R<sub>14</sub>-D<sub>7</sub>-D<sub>2</sub>, at about 20 V. The amplification of the input stage is restricted to 3.5 by resistors R<sub>6</sub> and R<sub>10</sub>. To keep the bandwidth at the output of the cascode circuit as large as possible, the values of collector resistors R<sub>7</sub> and R<sub>8</sub>-P<sub>1</sub> are fairly low. The preset, P<sub>1</sub>, serves to eliminate any inequalities in the d.c. operating points. Lag compensation is provided by R<sub>5</sub>-C<sub>3</sub>. The capacitor determines the open-loop crossover point, while the resistor keeps the phase shift down. The d.c. operating point of the FETs is set by a constant-current source around T<sub>3</sub>. Differential amplifier T<sub>6</sub>-T<sub>7</sub>, together with T<sub>8</sub> and T<sub>9</sub>, also form a cascode circuit to keep the bandwidth as large as possible. The output of T<sub>8</sub> is fed to the current

amplifier via current mirror T<sub>10</sub>-T<sub>11</sub> and terminal B. The signals at terminals A and B are, therefore, in phase with one another.

Lead-compensation capacitors C<sub>4</sub> and C<sub>5</sub> serve to maximize the bandwidth of the second cascode circuit.

**Current amplifier.** The current amplifier consists of drivers T<sub>20</sub> and T<sub>22</sub> followed by power transistors T<sub>21</sub>, T<sub>24</sub>, T<sub>25</sub> and T<sub>26</sub>, which, as already mentioned, are connected in a compound configuration. This section also provides a small voltage amplification due to resistors R<sub>57</sub> and R<sub>62</sub>.

The power transistors are protected by diodes D<sub>9</sub> and D<sub>10</sub> against any large negative voltage surges that may originate in the loudspeaker system. The d.c. operating point is provided by transistor T<sub>20</sub>, which acts as an adjustable zener diode. This stage enables the setting of the voltage drop across T<sub>21</sub>, R<sub>50</sub>, R<sub>55</sub>, and T<sub>22</sub>, and thus that across resistors R<sub>49</sub> and R<sub>56</sub>, which determine the quiescent current of the power transistors.

Transistor T<sub>20</sub> is mounted on the heat-sink for the drivers and power transistors to guarantee good thermal feedback: this ensures that the quiescent current remains steady even when the temperature rises. The quiescent current is about 100 mA per transistor, so that the output stages can comfortably handle small signals in class A.

Boucherot network R<sub>64</sub>-C<sub>28</sub> ensures that the output is loaded even at high frequencies.

Inductor L<sub>1</sub> limits current surges caused by predominantly capacitive loads at the output.

The signal at the collectors of the power transistors is fed back to the gate of T<sub>2</sub> in the voltage amplifier via R<sub>6</sub>. The ratio R<sub>6</sub>:R<sub>4</sub> determines the voltage amplification: with values as shown, this amounts to 3.5. The input sensitivity of the voltage amplifier is then 1.1 V r.m.s.

**Power supply.** The power supply uses two mains transformers in series, Tr<sub>1</sub> and Tr<sub>2</sub>. Note that Fig. 3 shows the power supply for a mono amplifier.

Transformer Tr<sub>2</sub> is a heavy-duty toroidal type with a centre-tapped secondary: each half delivers about 40 V a.c. Full-wave rectification is effected by bridge rectifier B<sub>1</sub> and smoothing of the d.c. voltage is carried out by four 10,000  $\mu$ F electrolytic capacitors: C<sub>31</sub> and C<sub>32</sub>. The open-circuit supply voltage for the power transistors is about  $\pm 57$  V; at full load, this drops to around  $\pm 51$  V.

The series connection of Tr<sub>1</sub> and Tr<sub>2</sub> provides a supply voltage of  $\pm 70$  V for the voltage amplifier. This supply is regulated at  $\pm 60$  V by discrete regulators T<sub>12</sub> to T<sub>15</sub> and T<sub>16</sub> to T<sub>19</sub> respectively.

A differential amplifier in each regulator compares the output voltage with a zener-derived reference potential; any differences are eliminated by a darlington series regulator in the two supply lines. Presets P<sub>2</sub> and P<sub>3</sub> facilitate the setting of the respective voltage to their correct level.

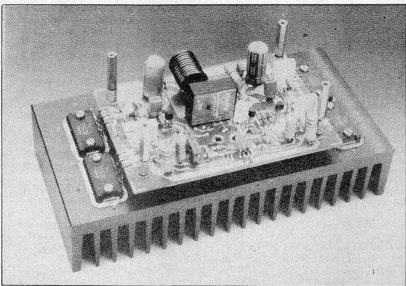

Fig. 6. After the drivers and power transistors have been fitted to the heat sink, the current amplifier board is mounted above with the aid of spacers.

**Protection circuit.** The protection circuit will be described next month, but its connections to the other parts of the circuit are already shown in Fig. 3.

The output relay is located on the current amplifier board to ensure the shortest possible loudspeaker connections.

Transistors T<sub>27</sub> and T<sub>30</sub> monitor the current through emitter resistors R<sub>54</sub> and R<sub>55</sub> respectively and, if necessary, actuate the protection circuit via T<sub>28</sub> and T<sub>29</sub>. This happens when the output current exceeds 10 A.

### Practical design

The sub-division of the circuit over four PCBs makes the construction rather easier to keep under control. The construction details will be given next month, but Fig. 1 gives some idea what the LFA-150 looks like.

The PCBs have been designed in a way that makes it possible for three of them to be fixed together with the aid of suitable spacers. Only the PSU board is mounted by itself in the enclosure.

The drivers, power transistors and T<sub>30</sub> are all screwed firmly to the heat sink with their terminals away from the heat sink. The current amplifier board is mounted on top of this arrangement (see Fig. 6), then the voltage amplifier board on top of that (see Fig. 7), and finally the protection board at the very top.

All connections carrying large currents on the current amplifier board have been kept as short as possible. This explains the rather strange position of the output relay at the centre of the board.

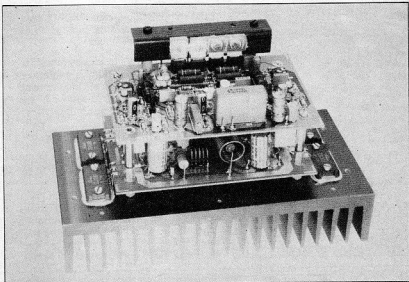

Fig. 7. The voltage amplifier board is mounted above the current amplifier board, again with the aid of suitable spacers.

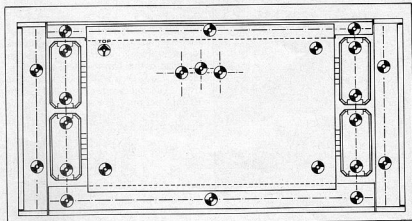

Fig. 8. Drilling diagram of heat sink.

## MAINS SIGNALLING

by A.M. Karailiev

Mains signalling is a method by which signals can be superimposed on mains wiring for remote control of electrical equipment. Typical applications are the control of street lighting, space heating, energy management systems and many other control switching applications in domestic, commercial and industrial premises.

The operating principle of the proposed modulator is shown in Fig. 1. Two thyristors, Th<sub>1</sub> and Th<sub>2</sub>, are connected in parallel across a variable inductor. Th<sub>1</sub> and Th<sub>2</sub> are controlled via optical fibres connected to the control centre.

Normally, the thyristors are open, so that the total alternating supply current passes through them and the inductor. In this state, there is no modulation, since the modulation voltage, U<sub>0</sub>, is nought. This changes when one of the

thyristors is closed, since then U<sub>0</sub> > 0.01U<sub>0</sub> — the transmitter is sending a signal into the mains network. In the simplest case, the receiver detects U<sub>0</sub>, and switches on a certain load, or group of loads. The second thyristor is

included to provide a complementary-phase signal  $U_0$  that can be used for switching off the load(s). The main function of the variable inductance is to ensure that the amplitude of  $U_0$  is virtually independent of the load current. To achieve this, the control centre sets the required inductance with the aid of a servo-motor.

## Modulation type

The modulation voltage should be not smaller than  $0.01U_-$  to allow a suitable noise margin for the receiver, and not greater than about  $0.05U_-$  to prevent it disturbing the operation of certain loads. In analogy with ordinary amplitude modulation, the modulation depth, or relative amplitude of  $U_0$  with respect to  $U_-$ , is expressed as

$$m = \frac{U_0(\max)}{U_-(\max)}$$

The modulation method used in the above control system is less simple to qualify than would be expected. It could be called a special form of *amplitude modulation*, since the modulation voltage is unipolar, causing amplitude

variation of either the positive or negative half cycles of the carrier voltage, but not both simultaneously. The system could also be considered as based on *phase modulation*, because it involves the sum of two amplitude-modulated voltages of equal frequency but opposite phase. *Waveform modulation* may be a suitable qualification because the modulation voltage,  $U_0$ , effectively changes the waveform of the sinusoidal carrier voltage.

Mathematical and experimental analyses of the spectrum of the modulated voltage supplied by the proposed system show that it consists mainly of even harmonics, among which the second,  $2f$ , dominates. In this regard, the change of the carrier waveform caused by the modulation could be qualified as *distortion*, and can be expressed as a distortion factor,  $k$ . It can be shown that this is roughly equal to the previously mentioned modulation depth:

$$k = \sqrt{\frac{U_2^2}{U_1^2}} \approx \frac{U_2}{U_1} = m$$

But this is not a pure type of modulation. In order to improve the noise resistance of the receiver, the maximum positive and negative excursions of the

carrier voltage have to be decreased in an alternative fashion, which has the basic elements of phase modulation.

Being able to bring about a difference  $\Delta U_0$  between the positive and negative maximum excursions of  $U_-$  by means of a modulator in a high-voltage line is essentially the same as injecting a signal of amplitude  $0.5\Delta U_0$  and of frequency  $2f$  — the frequency of the second harmonic.

Normally, odd-numbered harmonics with  $k=0.03-0.04$  are permanently present in many mains networks, while even-numbered harmonics appear only from time to time when large loads are switched on or off. Their total duration is relatively short at about 5% of the 'quiet' periods.

## Encoding system

Encoding of the modulation signal is considered in view of the relatively high noise level on most mains networks. The timing diagrams of Fig. 2a and 2b show how the control centre sends trigger pulses to the thyristors to switch a load on and off respectively. The load, or group of loads, controlled is selected by assigning a corresponding value to  $k$ . The block diagram of the receiver is given in Fig. 3, and the practical circuit

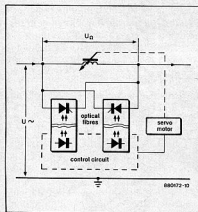

Fig. 1. Series connection of a modulator in a high-voltage line.

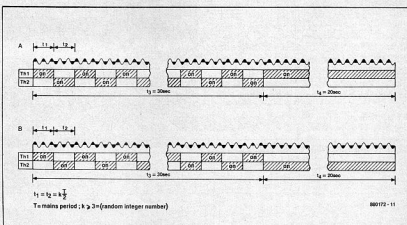

Fig. 2. Thyristor timing diagrams: load on (2a) and load off (2b).

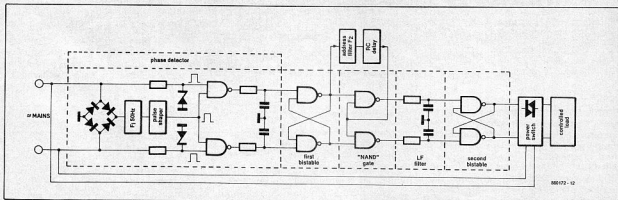

Fig. 3. Block diagram of the selective receiver.

in Fig. 4. A full-wave rectifier drives an active filter. In the absence of a modulation voltage, all maximum excursions of the rectified voltage are of equal amplitude, and there is no voltage at the output of the filter. When the mains network is modulated, the filter supplies a sinusoidal output voltage, whose phase shifts 180° when the thyristors in the

puts supplies the demodulated signal,  $U_{\omega}$ . Bistables, a load address decoder/filter and delay networks are then used to achieve reliable control of the power switch for the load. The filter is laid out in accordance with the load selection frequency:

$$f = 2/(k T)$$

The cost of the transmitter and receiver compares favourably with existing units based on so-called ripple control of the mains voltage.

Finally, Fig. 5 shows a suitable replacement for the variable inductor in the transmitter. It should be noted that the diodes have to be capable of handling

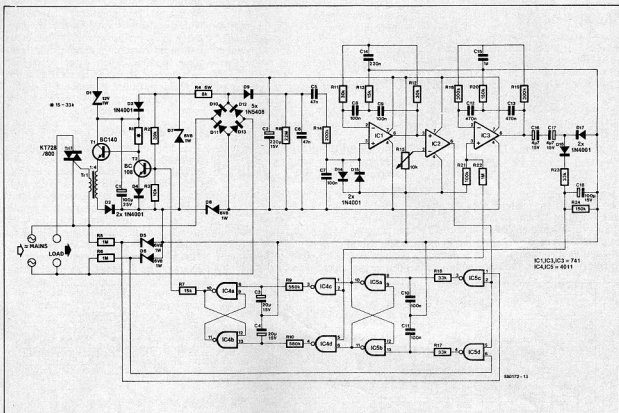

Fig. 4. Circuit diagram of the receiver.

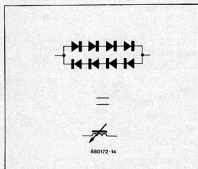

Fig. 5. Eight high-voltage diodes as a replacement for the variable inductor in the transmitter.

transmitter change state (on/off control). A phase detector compares the phase of the filter output signal with that of the mains voltage. One of its out-

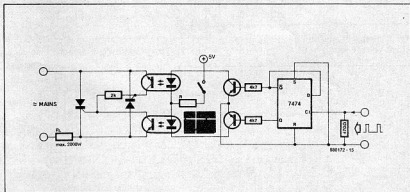

Fig. 6. Basic layout of a parallel modulator.

possible number of load selection frequencies is more than ten, but practical needs normally seldom exceed about five.

the total current demand of the load or group of loads. The block diagram of an alternative, parallel, modulator is shown in Fig. 6.

# PORTABLE MIDI KEYBOARD

A recently introduced integrated circuit makes a dream of many electronics enthusiasts come true: to build one's own MIDI keyboard around a handful of electronic components.

The portability of the keyboard described makes it ideal for 'first-aid' testing of MIDI equipment. Moreover, in conjunction with a microcomputer, it can be used for practising, composing and editing musical pieces in places where a full-size keyboard is cumbersome to use.

The Type E510 is a recently introduced integrated circuit that reduces the complexity of a MIDI keyboard to the extent that home construction of such a unit is at last within reach. Until recently, building one's own MIDI keyboard was way of out reach of the average electronics enthusiast because of cost and complexity. At that time, even the simplest of do-it-yourself MIDI keyboard required building blocks such as a processor, random-access memory, read-only memory, high-precision mechanical parts to ensure good dynamic key response (velocity), a musical keyboard, and a data entry keyboard, to mention but a few.

The E510 can be used with a musical keyboard of ten octaves (128 keys) whose keys are suitable for providing the velocity information. The only auxiliary components needed are an EPROM loaded with transposition data, two binary decoders, and, of course, key contacts.

The benefits of a portable keyboard are obvious: quick testing of MIDI instrument arrangements, practising and composing (parts of) musical pieces, participating in workshops, and trying out chords or tone combinations in situations where a full-size keyboard simply takes up too much space. The miniature keyboard is also very useful for simulating a temporarily absent instrument or full-size keyboard for editing sequences loaded in a sequencer, sounds in an expander, or scores in a computer system.

Apart from its function as a versatile accessory in the musical education field, the keyboard will also prove useful for experienced musicians whose principal instrument is, for example, the saxophone, the guitar or percussion — in any case, not the piano. Even if the mini keyboard serves as a mere gadget, it still deserves its very own place among far more complex MIDI equipment.

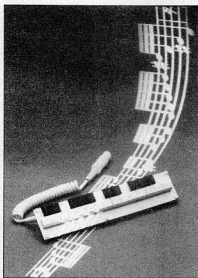

## MIDI KEYBOARD

- Overall size geared to portable applications.
- Electronic circuit complies with MIDI standard (incl. velocity).
- Miniature keys and control circuit on compact double-sided PCB.
- Range: 2 octaves and 1 note (25 keys); from C to C.
- Switch-controlled transpose function over  $\pm 1$  octave.
- Switch-controlled MIDI channel selection (channel 1 or 2).
- Simple to power from mains adaptor with DC output.
- Low chip-count.

## MIDI keyboard: principle of operation

The task of the MIDI keyboard is to detect the individual states of the keys to enable polyphonic playing. This means that a number of notes can simultane-

ously appear or disappear, notes can last when others stop, and notes can appear before others have disappeared. It is the aspect of polyphony that makes a musical keyboard functionally completely different from, say, a computer or data entry keyboard.

The 'key state' means that it is either released (the corresponding contact is in the non-actuated, or rest position), pressed (the corresponding contact is actuated), or in between these extremes. The time that lapses between the instant when a key is no longer in the rest position, and the instant it reaches the work position, is translated into a VELOCITY value. Evidently, the velocity at which the key is pressed is proportional to the

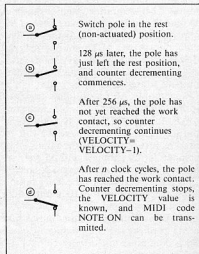

Fig. 1. The main functions of the electronics in the MIDI keyboard are to analyse the position of the keys, and to measure the time that lapses between the opening and closing of the contacts, for both directions of travel of the switch pole. Although in principle available on the small MIDI keyboard discussed here, the latter function is, unfortunately, of no use because the relevant switches are of a type whose pole travel is virtually instantaneous rather than continuous.

intensity with which the player strikes it. The softer the key is struck, the more time will lapse before the pole of the key has travelled from the rest contact to the work contact. This time is measured by counting down from 127 to 1 (see Fig. 1); the smaller the final count, the softer the key-touch.

When it is detected that a key is no longer in the non-actuated position, nothing happens on the MIDI output of the keyboard. Counting down, however, commences or continues. Code NOTE ON is not transmitted until the pole reaches the work contact. If the minimum VELOCITY value is reached by decrementing before the pole reaches the work contact, it is assigned the lowest value, 1. Basically the same happens when a key pole leaves the work position to return to the rest position. The scanning of a MIDI keyboard thus entails the fastest possible analysis of the state of each key. In practice, this is achieved by an electronic circuit that works in combination with mechanical change-over (toggle) switches to derive key on/off and velocity information.

## MIDI keyboard controller Type E510

Figure 2 shows the internal structure and pinning of the programmed MIDI keyboard controller Type E510. The power supply is conventionally connected to pins 8 and 16. The keyboard scanning signal and the timing of the serial MIDI data are derived from an on-chip clock oscillator that operates with an external 4 MHz quartz crystal connected to pins 14 and 15 (pin 15 may be used for applying an external clock signal). The data rate at the MIDI output may be doubled by fitting an 8 MHz crystal. Pin 13 should always be connected to the positive supply line.

Chip outputs A0 to A6 allow the controller to scan up to  $2^7=128$  addresses (= keys). The MIDI data is available at output SO (pin 9). This output can be used in two ways: it can be made TTL-compatible by fitting a pull-up resistor, or it can function as a current-source by fitting a series resistor. The latter option is used here to give a MIDI-compatible current loop output.

Input BE is connected to the 'bused' rest contacts of the switches. Similarly, input BS is connected to the work contacts of the switches.

The pole of a switch addressed by the E510 is made logic low. During scanning, when the pole is at the rest position, the level of line BE is logic low instead of logic high (normal state due to pull-up). When the key pole has reached the work contact, BS goes logic low. Neither BS nor BE is low when the pole is anywhere between the rest and the

## THE MIDI STANDARD: A BRIEF RECAPITULATION

The acronym MIDI stands for *Musical Instrument Digital Interface*. This standard has been designed to allow digitally-controlled musical instruments to communicate in a system (note that digital control often implies the use of a microprocessor or microcontroller, although this is, of course, not always necessary). The MIDI interface is basically a serial data link, based on a current loop. The data format is: 1 start bit, 8 data bits, and 1 stop bit. The data speed, 31.25 kilobits per second, is high relative to that used for many types of computer peripherals, but may still be too slow for real-time operations of a complexity beyond that of the most rudimentary types. The bulk of MIDI data is formed by the notes (*events*), played on a keyboard, or transmitted by an instrument. This recapitulation covers only MIDI events such as the NOTE ON and NOTE OFF messages.

Of the three bytes in a 'NOTE ON' message, the second one carries the note value. With the MSB (most significant bit) set to 0 to indicate that the byte is a data type, this leaves only seven bits to carry the note value. This gives a range of  $2^7$  values, and these are assigned numbers from 1 to 127. The value of 60 is equivalent to the middle C. The interval between any two adjacent numbers is a semitone, so that a total compass of about ten and a half octaves is available.

MIDI VALUES: NOTES											
0	12	24	36	48	60	72	84	96	108	120	127
		C1	C2	C3	C4	C5	C6	C7	C8		
range of piano											

In addition to PITCH, the MIDI standard uses parameters NOTE ON and NOTE OFF (or KEY ON and KEY OFF). The first corresponds to the actuation of a key (or, in more general terms, to the start of the note), the second to the release of the key (end of the note). In reality, the relation between the duration of the note and the transmission of data NOTE ON and NOTE OFF is much more complex. Although the start of a note usually coincides with the transmission of code NOTE ON, the complementary code, NOTE OFF, rarely marks the end of the note — usually, by the time NOTE OFF is transmitted, the note is already ended (in the case of a percussion sound without sustain), or it still sounds (long sustain).

The third byte in the 'NOTE ON' message provides keyboard velocity information. Ranged in values from 1 to 127, the velocity is normally used to control the loudness of the notes (0 = 'key off'; 1 = pianississimo — *ppp*; 127 = fortississimo — *fff*). It should be borne in mind, however, that there is no specified relationship between the velocity value and the loudness. If a MIDI instrument is not designed to handle velocity information, it adopts a default value (usually 64).

MIDI VALUES: VELOCITY											
0	1							64			127
OFF	ppp	pp	p	mp	mf	f	ff	fff			

Since a single MIDI interface can be used for connecting several MIDI devices, provision has been made to identify data to ensure it is correctly routed in multi-instrument set-ups. This data marking allows individual addressing of any instrument connected to a single MIDI interface. The MIDI standard specifies up to 16 channels, numbered 0 through 15 (sometimes 1 through 16), which means that any one of up to 16 instruments can be controlled independently and individually. In the case of the NOTE ON and NOTE OFF information, the channel number forms part of the ON or OFF code.

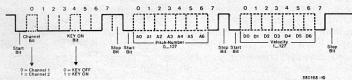

The above diagram shows a MIDI message sent by a keyboard when a key is actuated. The start bit is followed by an 8-bit word, in which the first 4 bits (0 through 3; least significant nibble) indicate the channel number (the keyboard described in this article can drive only two channels). The last bit, (number 7; most significant bit) is logic high to indicate that the byte sent represents *status information*, i.e., it is not, strictly speaking, a *dataword*. The logic level of bit 4 provides the KEY ON/OFF (NOTE ON/G $\bar{O}$ F) information: 0 = OFF; 1 = ON.

The six bits that indicate the key number follow the start bit of the second byte. Bit 7 of a databyte is always logic low. The six bits of the third byte (second databyte) hold the velocity information. Bit 7 is logic low to mark that the byte it forms part of is still a databyte. In the present case, the MIDI message is terminated with the stop bit of the third byte.

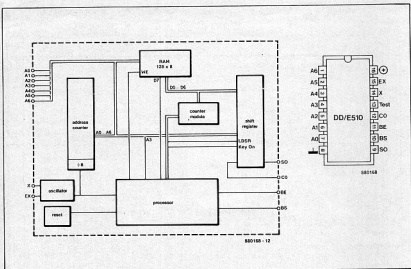

Fig. 2. Internal structure and pinning of the polyphonic MIDI keyboard controller Type E510. This chip supports the use of a 128-key keyboard with up to 10 octaves, and transmits MIDI values for VELOCITY, NOTE ON and NOTE OFF.

work contact. The above arrangement is summarized in Table 1.

The logic level at chip input C0 (pin 12) determines the current MIDI channel: C0=0=channel 0; C0=1=channel 1.

### Circuit description

The crucial components in the circuit diagram of Fig. 3 are controller IC<sub>1</sub> (E510) and decoders/demultiplexers IC<sub>2</sub> and IC<sub>4</sub>. EPROM IC<sub>2</sub> has the auxiliary

Table 1.

key	BE	BS	function
1	x	x	not analyzed
0	0	1	pole at rest contact
0	1	0	pole at work contact
0	1	1	pole travelling
0	0	0	impossible

x = irrelevant

function of code converter.

The operation of the circuit is best understood if IC<sub>2</sub> is initially ignored. It is assumed, therefore, that the address outputs of IC<sub>1</sub> drive IC<sub>3</sub> and IC<sub>4</sub> direct. On its outputs A0 to A6, the E510 counts from 0 to 127. Each time the counter is incremented, another output on IC<sub>3</sub>, and then IC<sub>4</sub>, goes low. This cyclic counting up forms the scanning of the keyboard. Each time the E510 pulls one of its address lines logic low, it reads back the logic levels of lines BS and BE to determine the current state of the addressed key. This state is combined with that read during a previous scan (i.e., 128 μs earlier at  $f_{XTAL}=4$  MHz). The

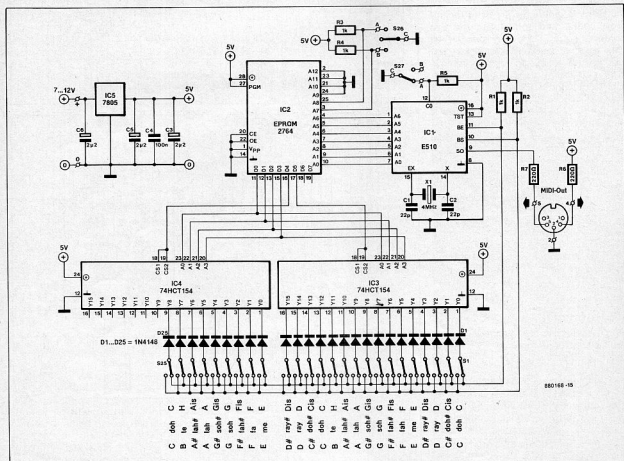

Fig. 3. Circuit diagram of the small MIDI keyboard.

result of the combination is deduced as shown in Table 2.

That the keyboard described here has 25 instead of the maximum number of 128 matters very little as far as the electronics are concerned, since BE and BS simply remain logic high simultaneously for the 103 non-existing keys, and state  $BE=BS=1$  is effectively ignored by the E510. Although the contact travel time of the Digitast keys used in the MIDI keyboard can be measured with some precision, it will be found that this is largely constant, i.e., hardly subject to applied force. This is because Digitast keys have tactile feedback (they produce a click when pressed). The upshot of it is that the VELOCITY value transmitted by the *standard* version of the keyboard is of no practical use.

As already noted, EPROM IC2 functions as a code converter in the present circuit. The E510 counts cyclically from 0 to 127. In the absence of the EPROM, the two octaves of the keyboard would be comprised in the lowest range of the scale covered by the PITCH parameter, i.e., between note 0 and 24. Also, double addressing of the decoders in the circuit would cause a single key to provide several, different, MIDI codes simultaneously. The task of the EPROM is, therefore, to ignore the lowest of the address codes, and to activate the two decoders (74HCT154) *only once* when the counting has reached a value that corresponds to audible notes in the middle of the useful range.

The second duty of the EPROM is to switch between two address ranges, which results in the transpose function. This is effectively done with the aid of a toggle switch with a centre contact,  $S_{27}$ , that determines the logic level on EPROM address inputs A7 and A8. The EPROM converts the addresses supplied by the E510 by adding or subtracting the equivalent of one octave. For example, when the address of note 60 is applied, the EPROM converts this to an address that corresponds to note 72, one octave higher. The contents of the EPROM are listed in Table 3. A Type 2764 is used here because this is currently the least expensive EPROM.

### Split programming extension

Switch  $S_{27}$  determines the channel selection by controlling the logic level applied to input C0 of the E510.

Instead of manually giving a channel selection command, it is also possible to do this via the keyboard by splitting this into zones. Figure 4 shows the circuit diagram of the optional extension to achieve this. Notes played to the left or the right of the split go to MIDI channel 1 or 2 respectively. The split is defined by pressing the PROGRAM switch together with the desired key on the

Table 2.

Previous state	New state	Event	Key state
rest $BE=0; BS=1$	rest $BE=0; BS=1$	none	
rest $BE=0; BS=1$	intermediary $BE=1; BS=1$	start count	
intermediary $BE=1; BS=1$	intermediary $BE=1; BS=1$	continue count (to 1)	
intermediary $BE=1; BS=1$	work $BE=1; BS=0$	end of count message MIDI NOTE ON	
work $BE=1; BS=0$	intermediary $BE=1; BS=1$	start count	
intermediary $BE=1; BS=1$	intermediary $BE=1; BS=1$	continue count (to 1)	
intermediary $BE=1; BS=1$	rest $BE=0; BS=1$	end of count message MIDI NOTE OFF C0 = MIDI CHANNEL A6...A0 = PITCH count = VELOCITY	

0 = active  
count = decrement counter

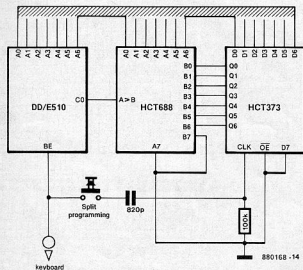

Fig. 4. Optional add-on circuit to achieve programmable split zoning.



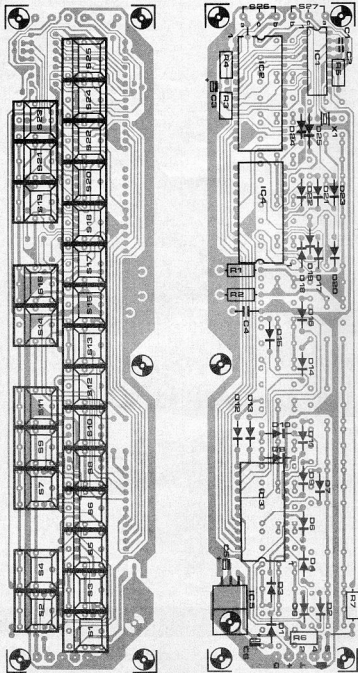

Fig. 5. Component mounting plan of the printed circuit board for the MIDI keyboard.

keyboard. The corresponding key number is then latched into the 74HCT373 octal bistable. Byte comparator 74HCT688 drives input C0 of the E510 logic low when the current key code is greater than that of the split, which is read from the latch. The programmable split option is not supported on the printed circuit board for the MIDI

keyboard, since this was desired to remain as small as possible.

### Construction

The following constructional description is slightly more elaborate than usual to enable anyone, even those with only limited experience in the electronics field, to build the keyboard successfully.

### Parts list

#### Resistors ( $\pm 5\%$ ):

R1...R5 incl. = 1K0  
R6;R7 = 220R

#### Capacitors:

C1,C2 = 22p  
C3;C5;C6 = 2 $\mu$ 2; 25 V; tantalum  
C4 = 100n

#### Semiconductors:

D1...D25 incl. = 1N4148  
IC1 = E510<sup>\*</sup>  
IC2 = 2764 (ESS567);

IC3;IC4 = 74HCT154  
IC5 = 7805

#### Miscellaneous:

S1...S25 incl. = miniature Digitast toggle (SPDT) key.  
S26 = miniature toggle (SPDT) switch with centre position.  
S27 = miniature SPDT switch.  
X1 = quartz crystal 4.00 MHz  
PCB Type 880168

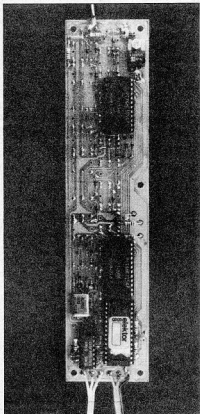

Prototype of the MIDI keyboard

**Table 3** TRANSDUCTION DATA  
Addresses applied to transposition EPROM:

S26		count from 0 to 128						note	C	S26	
A8	A7	A6	A5	A4	A3	A2	A1				A0
0	1	0	1	0	0	1	0	0	n° 36	2	-1 oct.
1	0	0	1	1	1	1	0	0	n° 60	4	+1 oct.
1	1	0	1	1	0	0	0	0	n° 48	3	normal

Output data supplied by transposition EPROM:

D7	D6	D5	D4	D3	D2	D1	D0	hex	
NC	NC	0	1	0	0	0	0	10	keys 0 to 15 74HCT154/IC3
NC	NC	0	1	1	1	1	1		
NC	NC	1	0	0	0	0	0		keys 16 to 25 74HCT154/IC4
NC	NC	1	0	1	0	0	0	28	

**Table 4.** EPROM CONTENTS

	0	1	2	3	4	5	6	7	8	9	A	B	C	D	E	F
00A					10	11	12	13	14	15	16	17	18	19	1A	1B
00B	1C	1D	1E	1F	20	21	22	23	24	25	26	27	28			
...																
013													10	11	12	13
014	14	15	16	17	18	19	1A	1B	1C	1D	1E	1F	20	21	22	23
015	24	25	26	27	28											
...																
01B	10	11	12	13	14	15	16	17	18	19	1A	1B	1C	1D	1E	1F
01C	20	21	22	23	24	25	26	27	28							

Addresses not given are left blank (FF)

Construction is not difficult, but requires great care and precision because components are fitted at both sides of the printed circuit board, which is quite densely populated.

The first thing to note is that the components, with the exception of the keys, are fitted at the track side of the board. The holes in the board are intended for the wires and the keys. All other component terminals are cut to a suitable length, preformed, and soldered direct to the relevant copper islands.

Commence construction at the track side by fitting the two wire links: one between R<sub>6</sub> and R<sub>7</sub>, and the other, a very short one, close to solder terminal a of S<sub>26</sub> (in both cases, use insulated wire to prevent a short-circuit with tracks running below). Next, mount the 25 Digitast keys at the reverse side of the board (note that a number of keys can not be soldered any more once the integrated circuits have been fitted). Study the orientation of each and every diode before fitting it!

Mount the solder terminals for the wires to the board (MIDI output and power supply), and then those for S<sub>26</sub> and S<sub>27</sub>. Depending on personal preference, these switches are either mounted direct on to

the board (to the right of the Digitast keys), or on the front panel of the enclosure that houses the MIDI keyboard. Cut the terminals of voltage regulator IC<sub>5</sub> to a length of about 3 mm from the enclosure, bend them over, and place their ends on the spots provided. Insert an insulating mica washer between the metal tab of the regulator and the PCB surface. Secure the regulator with a short

M3 bolt and nut.

Take great care to avoid short-circuits between component terminals and nearby tracks. Make sure that the leads of the quartz crystal are left long enough to enable the metal enclosure to be bent towards the PCB without touching the solder joints below. Bend D<sub>25</sub> slightly away from the crystal enclosure.

There is no objection to confident and experienced constructors soldering the integrated circuits direct on to the board. If you are hesitant about doing this, however, use low-profile IC sockets. Since the E510 may have to be removed for use later in a full-size touch-sensitive keyboard (see below), it is recommended in all cases to fit this IC in a socket.

Finally, be sure to use good-quality strain reliefs for the MIDI output and supply cables.

## From mini to full-size

The electronics in the MIDI keyboard is suitable for connecting to a 'real' keyboard, i.e., one of standard size and having change-over key contacts of a quality that ensures equal VELOCITY values over the full keyboard range.

The function of a sustain pedal can be created by inserting a push-to-break button in the pulled-up BE line to the E510. This switch, when pressed, prevents the E510 from detecting that actuated keys have returned to their rest position, in which case BE is logic low.

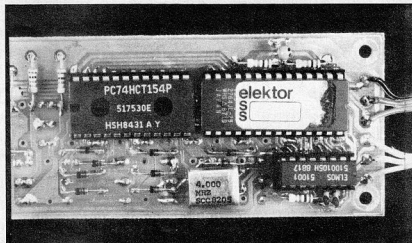

# OPTOELECTRONICS

by K. Roberts, BA

Optoelectronics is one of the fastest growing branches of electronics and British research and development is leading the world in many of its facets. Although this technical excellence is not (yet) matched in the commercial sector, companies operating in the opto-electronics field are increasingly exploring export markets and seeking international collaboration. Already, many export more than half their production and some export nearly all of it.

Optoelectronics may be defined as the technology that makes use of the interaction between photons (small packets of light energy) and electrons. The study and science of this interaction is called photoelectronics, often, particularly in the USA, contracted to photonics.

Broadly speaking, optoelectronic products may be categorized into sensors (responders to light), emitters (of light), and users (of light), which are often a combination of the first two.

Sensors comprise, among others, photocells, also called light-dependent resistors (LDR); solar cells; photo-diodes; and phototransistors.

Emitters comprise ordinary light bulbs; light-emitting diodes (LED); gas discharge tubes; lasers; electroluminescent displays; and cathode ray tubes.

Users comprise optocouplers, sometimes called opto-isolators; infra-red alarm and remote control systems; security installations; and metrological devices.

## Sensors

An LDR (photo-cell) consists of a thin polycrystalline film of cadmium-sulphate sandwiched between two metal

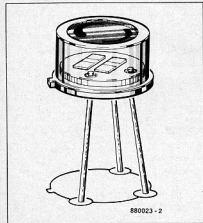

Fig. 1. Typical infra-red sensor.

contacts. The potential across these contacts is directly proportional to the current flowing through the contacts. The conductivity of the cadmium-sulphate increases greatly (by a factor of about  $10^5$ ) when it is subjected to electromagnetic radiation of a wavelength between, roughly,  $3 \times 10^{-6}$  m and  $3 \times 10^{-5}$  m. This results in a photocurrent, superimposed on the small dark current, flowing in an external circuit.

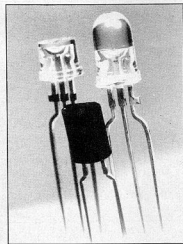

Fig. 2. Some typical phototransistors with in the centre an infra-red photodiode.

A solar cell is a photovoltaic device that converts light directly into electrical energy. It is essentially a *p-n* junction: by far the largest number of solar cells currently manufactured are made from crystalline silicon. Others are made from amorphous silicon, copper sulphide-cadmium sulphide, gallium arsenide, or cadmium-selenium. See Ref. 1.

A photodiode, either of the depletion-layer or of the avalanche type, has its *p-n* junction exposed to external light. The depletion layer type, operated below its break-down voltage, produces excess

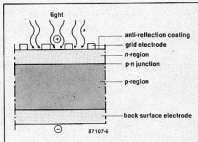

Fig. 3. Basic construction of silicon solar cell.

electron-hole pairs when radiation in the UV-IR region falls on to the junction. The pairs in or near the depletion layer cross the junction and produce a photocurrent. In the avalanche type, operated above its break-down voltage, current multiplication of the electron-hole pairs generated by incident illumination ensues owing to avalanche break-down.

A phototransistor is a bipolar junction transistor whose junctions are exposed to external light. It is normally operated in the common-emitter configuration. When light in the UV-IR region falls on to the junction, a base current is produced, and the normal current-amplifying action causes a greatly amplified collector current. The phototransistor is, of course, far more sensitive than the photodiode.

## Emitters

A light-emitting diode (LED) is a *p-n* junction that emits light as a result of recombination of excess electron-hole pairs. The emission is normally a fairly narrow bandwidth of visible (red, orange, yellow or green) or infra-red light. The colour is a function of the semiconductor material used for the junction. LEDs typically require forward operating voltages of about 2 V and forward currents of 10 to 20 mA. A gas-discharge, or fluorescent, tube

normally contains a small amount of argon together with a little mercury. It has two electrodes (filaments) that are coated with a mixture of barium and strontium oxides. The resistance between the electrodes is high until the gas is ionized. Gas ionization is usually brought about by the application of a very high voltage (of the order of 1500–2000 V) across the two electrodes.

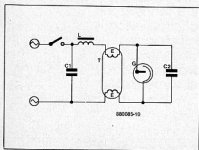

Fig. 4. Circuit of conventional low-pressure fluorescent tube.

The high voltage is normally induced across a starter choke by the sudden disruption of the current through the choke.

The laser was developed by Theodore Maiman in 1960. Light emitted by a laser differs from normal light in two important respects: it is coherent, i.e., all the photons are in phase; and it is of one frequency only.

There are many types of laser: small output He-Ne lasers, primarily intended for use in laboratories; argon-ion lasers for medical applications; carbon-dioxide lasers for industrial uses; dye lasers for use in spectroscopy; high output Nd/YAG lasers for surgical applications excimer lasers for use in chemical analysis and semiconductor processing; and, most common of all, semiconductor, or injection, lasers. The semiconductor laser is of prime importance in modern (fibre optic) communications, optical memories, and compact disc players. See Ref. 2 and 3.

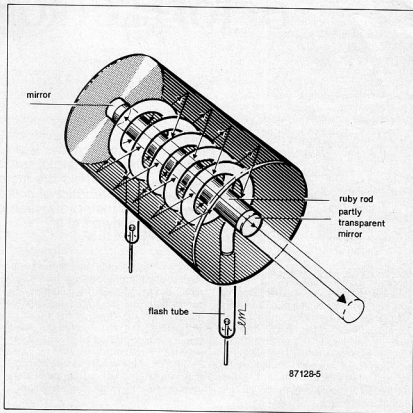

Fig. 5. Artist's impression of the construction of a ruby laser.

Electroluminescent displays make use of the ability of phosphorus to emit light continuously when a voltage is applied to it. The most commonly found application of this phenomenon is in the screen of a cathode ray tube as used in many hundreds of millions of TV sets the world over, not to mention the millions of computer monitors and oscilloscopes. Such a display consists of a sandwich of a luminescent-phosphorus layer and two transparent metal films. When an a.c. voltage is applied to the films, the phosphorus glows through the films.

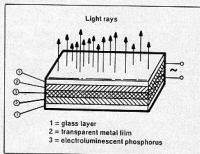

Fig. 6. Basic construction of electroluminescent display.

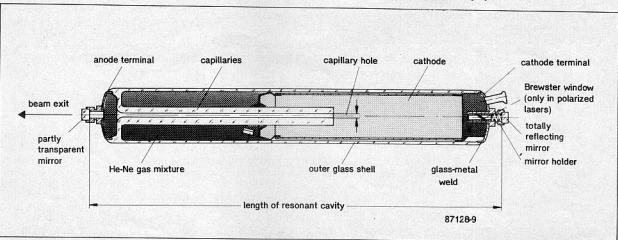

Fig. 7. Cross-sectional view of a He-Ne laser (courtesy of Siemens).

## Users of light

Optocouplers, sometimes called optoisolators, are devices that consist basically of a light-emitting diode and a phototransistor that are optically coupled within a light-excluding case. Optocouplers may be used with digital or analogue signals. They are normally specified by their isolation voltage (also called common mode rejection—CMR), speed (propagation delay), and forward coupling, normally called current transfer ratio—CTR. A typical, good-quality optocoupler has a CMR of about 2 kV, a propagation delay of around 5 ns, and a CTR, expressed as the ratio of the output current to the input current, of 30%.

Alarm and security systems often depend on the combination of an optoelectronic sensor and emitter, usually operating with infra-red light. Such systems may use a single or dual light-beam transmitter-receiver, in which the receiver is switched on to actuate an alarm when the beam from the transmitter is broken by an object. There are also systems that operate by reflecting the light beam back to an integral light emitter-sensor with the aid of a prismatic mirror (which simplifies alignment as compared with a plane mirror). Infra-red remote control systems for use with TV receivers and audio systems, to name but a few, also use a transmitter (hand held) and receiver (located in the equipment to be controlled). The transmitter is usually controlled by a five-bit (for 32 codes) or a six-bit (for 64 codes) keypad. The code is transmitted by a number of IR LEDs. The coded signals are received by a photocell and fed to a decoder in the receiver. The decoder usually provides both digital outputs (channel changing, loudspeaker muting) and analogue outputs (volume control).

## The future

As already stated in the introduction to

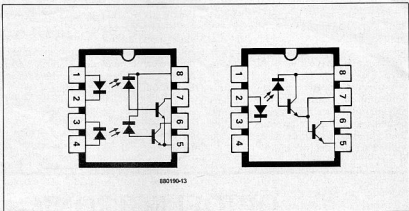

Fig. 8. Outline drawings of two types of optocoupler; the one on the right uses a darlington phototransistor for increased sensitivity.

this article, Britain is in the forefront of optoelectronic research and development. Unfortunately, many companies in the industry find it increasingly difficult, even more so than other electronics concerns, to find suitably trained and qualified staff.

In line with the increased outward looking of the optoelectronics industry is the widespread participation in European research programmes such as EUREKA, ESPRIT, and RACE in order to spread the cost of R&D. There is, furthermore, a growing co-operation between optoelectronics companies and universities, actively encouraged by the government. Of the many universities, particularly Heriot-Watt and Southampton Universities are in the vanguard of optoelectronics research. Moreover, the Royal Signals and Radar Establishment—RSRE—at Malvern is one of the world's leading defence research establishments. The Government has set up Defence Technology Enterprises (DTE) to exploit commercially the research undertaken at places such as RSRE. The Government has also co-operated in the setting up of the Optical Sensor Collaborative Association—OSCA.

Apart from well-established companies such as Plessey, GEC, STC, Barr & Stroud, Ferranti, and many others, a fairly new powerful force in the British optoelectronics industry is British Telecom's joint venture with the American giant Du Pont, called BT&D Technologies.

Most of the British industry is moving towards metallorganic chemical vapour deposition—MOCVD—manufacturing techniques that will make possible true mass production of complex optoelectronic devices.

There also appears to be a bright future for non-linear optical switches made from lithium niobate. Barr & Stroud, a Pilkington company, markets a range of lithium niobate optical ICs, including phase modulators, intensity modulators, and directional couplers operating in the IR region.

Although the UK is not so strong in laser manufacture, Philips Components, formerly Mullard, supplies most of the CD lasers required by its parent company Philips of Holland.

The largest producer of thermionic valves in Europe is EEV, a GEC company. Apart from thermionic valves,

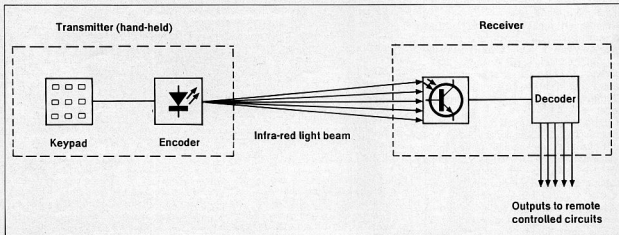

Fig. 9. Basic outline of an infra-red remote-control transmitter-receiver.

this company, which employs 2,700 personnel and has annual sales of some £80 million, manufactures liquid-crystal displays (LCDs), charge-coupled devices (CCDs), and image intensifiers made in MOCVD.

Another worldleader is the Midlands company of Hadland, which designs and manufactures high-speed electronic cameras and image converters. One of their cameras is said to run at over 600 million frames per second!

Pundits reckon that the world market for optoelectronic devices will grow from under £300 million in 1987 to around £800 million by 1992. Given the state of our research and development, there must be many rich pickings there for the British optoelectronics industry.

## OPTOELECTRONICS BRIEF

### A very Intelligent Computer Terminal

by Bill Pressdee

Over the last decade the thrust of innovation in information technology has moved gradually from mainframes towards minicomputers and specialist workstations. It is not surprising, therefore, that intelligent terminals systems development is now of considerable interest.

Lynwood Scientific Developments<sup>(1)</sup> of London, which claims to be the first independent European company to embed a microprocessor in a video display unit, is a world leader in the design and manufacture of sophisticated display technology. Moreover, it has an enviable reputation in the development of specialized systems for meeting clients' specific needs and for forming joint teams with them.

Nevertheless, it has a low market profile, possibly because it is involved in military projects with a high security classification. In fact, one is more likely, perhaps, to come across an original Lynwood terminal to which a major electronics manufacturer has attached its logo.

The philosophy adopted by Lynwood in manufacture involves concentrating operations into three specialist units: short run special products, such as those built for the Ministry of Defence; high volume runs; and production of logic boards and sub-assemblies. The company is unusual in today's world of volume output in that it maintains an extensive capability for specialized systems complementary to its hardware development.

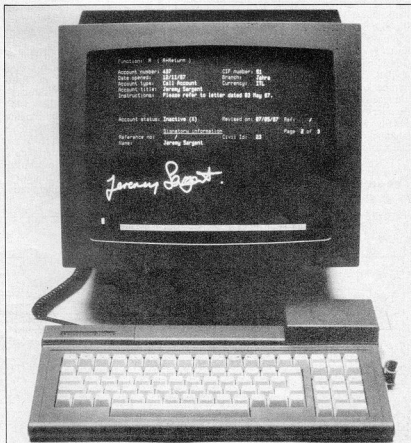

The j300 enables graphics to be shown together with file data — a possible extension to a criminal records facility.

## Sophisticated communications software

The successful Lynwood Alpha and Beta terminals have now been superseded by the latest range: the j102, j300, j500 and j700. Based on the Alpha terminal, these new displays represent an updating with a large number of systems uses in mind. The new Lynwood j300 high definition, intelligent display has an embedded Zilog Z8001 processor and 256k of display memory that enables sophisticated video and communications software to be used. Programs can be supplied for two or three emulators to operate within the same terminal concurrently, using split or virtual screens. Other programs can support a variety of communications protocols.

Through multiple ports, simultaneous communications can be maintained with separate host computers. Attached peripherals which make up the workstation for a system—such as various types of reader, letter quality printers, security devices and dispensers—can be controlled by the terminal, and the display can be used for local calculations or to execute terminal resident tasks.

The unit is compact and great attention has been paid to sound ergonomic design. Considerable care has also been taken in the placement of components which, coupled to the optional provision of fibre optic interfaces, is a clue that the company also supplies a version of the j300 to full Tempest security specification.

## Banking applications

The largest terminal is a 482 mm colour display with a resolution of 1280 by 1024 4-bit pixels. Graphics functions are executed by a powerful controller assisted by the terminal's Motorola 68010 processor incorporating a 2 Mb memory. Optionally, a Motorola 68020 and a 4 Mb memory can be provided. A large frame buffer can hold three 1280 by 1024 displays and the screen image may be built from selected parts of the frame buffer. This arrangement is designed for command and control applications where a static 16-colour geographic background can be overlaid with another 16-colour plane of dynamic information.

A system developed by Lynwood, initially in conjunction with the United Bank of Kuwait, has recently been adopted by a number of other banks in the Middle East. This sophisticated on-line teller system can display at a teller position all relevant account details and authorized signatures appropriate to an account.

The records are created via the signature capture station, using a facsimile reader in conjunction with a j300 which has a security badge reader so that an audit

trail of signature entry and authorization can be recorded. The information is sent as an ASCII alpha string to a database held on a separate processor that interfaces to whatever host processor the bank may use.

In another application Lynwood is providing integrated dealer workstations to various banks including the United Bank of Kuwait. These provide a number of screens controlled by a single keyboard and by virtue of its excellent emulation and communications programs, information from a plethora of sources can be co-ordinated and correlated.

They may be from in-house computers such as IBM, DEC, DG, Tandem, ICL and NCR or external networks, from Telex, via service gateways, and external services, such as Reuters, Teletext, Topic and Datastream while a page cache can be held within the workstation. Text and graphics can also be displayed on a common screen and controlled from the keyboard.

## Machine-readable passports

Another interesting use for the terminals is a machine-readable passport system developed in conjunction with De La Rue, the leading currency and passport printer, and marketed by De La Rue Identity Systems (2) of Basingstoke. It enables laborious manual infilling to be replaced by a flexible issuing system which is much faster and automatically logs the number of passports issued. At the point of entry to a country, immigration throughput is greatly improved and monitored information may be automatically recorded leading to improved security and control of visitors. Lynwood terminals have enjoyed considerable popularity with metropolitan police forces in the United Kingdom and other parts of the world. The terminals used in the London police system have been upgraded to interface with the X25 networking protocol of METNET.

The facility for multi-emulation enables the terminals to tap a number of resources to provide a criminal record information system with inputs from the Police Command network, the Police National Computer, and HOLMES, the Home Office serious crime investigation matching profiles dossier. These can be correlated on a single video display unit (VDU). At present, photographs of criminals have not yet been introduced into such system but it is only a matter of time as the technology is there to be used.

Terminals such as the j300 contain sufficient memory and processing power to have a significant effect on the overall system design. Not only can they help to reduce some of the problems, mainly concerned with real time, that are associated with certain types of computer sys-

tem, but they can also provide a much more effective man-machine interface that can be tailored to the needs of individual users.

To harness the hardware, the company has developed a range of software that is flexible in its approach to both communications and emulations. In addition, the company has examined specific applications to determine whether generalized packages can be developed that are project independent and capable of handling the hardware in a very flexible manner.

One of these, TRAPS, is a terminal-resident software package that enables a format-driven dialogue to be generated at the terminal. With the use of its processing power and memory, the most effective dialogue is produced while minimizing the demands on the host processor and communications network. Format-driven dialogues are particularly successful because they enable the user to be led through a set procedure with the input data being validated at all stages. Keystrokes and entry time are reduced by using prediction tables that anticipate character string matching within the validation.

## References.

- (1) Lynwood Scientific Developments Ltd, Unit Five, Bowling Green Lane, London EC 1R 0BD.
- (2) De La Rue Identity Systems Ltd, De La Rue House, Basing View, Basingstoke RG21 2EL.

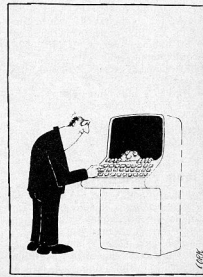

# BUS INTERFACE FOR HIGH-RESOLUTION LIQUID CRYSTAL SCREENS

## Part 1

Although large LC display modules are currently available in many shapes and sizes, their special serial input calls for the use of an interface to enable connection to a computer bus.

The interface described here is versatile, yet relatively simple to configure and program as a bus-connected device in a number of popular computer systems. Although the application discussed concentrates mainly on the 400x64 dot matrix LCD module Type LM40001 from Sharp, the interface board is also suitable for a number of similar units in Hitachi's LM series.

Liquid crystal display (LCD) units for text and graphics applications are usually supplied as a module consisting of a glass-protected, reflective backplane (the actual display), and a controller board attached to it at the rear side. The controller translates the data applied to its serial input into backplane waveforms, which result in dot patterns that form legible characters or graphic shapes. In most cases, LC controllers have an on-board character ROM. The serial format used for controlling LC display modules is usually of a type that bears no resemblance whatsoever to that adopted for, say, the well-known RS232 port. When a large, intelligent LC display module, such as the LM40001, is to be used in conjunction with a computer, an interface circuit is required as described in this article.

Among the computers that can be connected to the present interface are

- 6502-based systems (C64, C128, Acorn computers);
- Z80-based systems (CP/M and MSX computers);
- IBM PCs and compatibles;
- the *Elektor Electronics* BASIC computer <sup>(1)</sup>.

Significantly, the LCD interface can be controlled entirely in BASIC.

### Liquid crystal screens

Although Sharp's Type LM40001 is, strictly speaking, a liquid crystal display module, it is better qualified as a *liquid crystal screen* because of its large viewable area (220x35 mm), and its ability to process data as graphics information (individual dots can be addressed). This is in contrast to most

smaller LCD units, which are usually only capable of displaying text and numbers on 1, 2 or sometimes 4 lines, depending on the size.

An LC screen is essentially a dot-matrix display unit without predefined characters. The interface described here, in conjunction with the existing backplane controller on the LC screen module, makes it possible to combine dot patterns into legible characters, just as on a TV screen, or a dot-matrix printer.

Although the prototype of the interface was developed, tested and used in conjunction with the LM40001 from Sharp,

it can also be connected direct to Hitachi's Types LM200, LM021, LM212 and LM211. These, and similar units from other manufacturers, are occasionally offered inexpensively at rallies and in surplus stores (but make sure you obtain the relevant data sheets).

### Principle of operation

The block diagram of Fig. 1 shows that an address decoder is required to 'map' the LC screen in the computer's memory. Depending on the type of processor in the computer, this address can be in actual memory (e.g., 6502-based

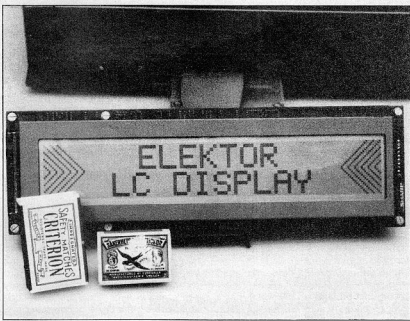



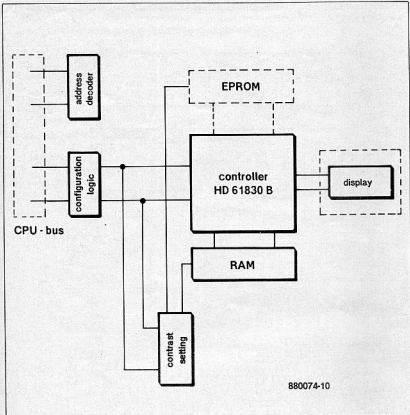

Fig. 1. Block diagram of the universal LC screen interface.

systems), or in the I/O segment (e.g., Z80-based systems). The configuration logic, shown as a separate block in Fig. 1, is required to ensure correct timing and combination of the pulses for the interface.

The 8 Kbyte RAM block is divided into two 4 Kbyte segments by a dedicated LCD controller chip, the Type HD61830B from Hitachi. In text mode, each 4 Kbyte screen memory holds the data for ten text windows. In graphics mode, the same memory holds one graphics screen. The difference in storage capacity between the text mode and the graphics mode is brought about by the fact that any ASCII character (a complex dot pattern) can be called up by only one byte, whereas, in graphics mode, that same single byte produces only a horizontal row of 8 dots.

The internal division of the screen memory in displayable windows is shown in Fig. 2. An external control signal provided by a latch divides the memory in two equal halves. The start address determines which 400 memory locations appear on screen ('display window'). Hence, there are 10 text screens (4096/400). The on-screen location of the next character loaded is determined by the cursor address, which is automatically incremented by one after the controller has displayed the current character.

Starting at cursor address 0, and assuming that the start address is not changed, characters following number 400 will not be displayed, but are still loaded in the screen memory. They become visible only when the start address is moved up accordingly ('scrolling'). Old data then disappears from the screen, but remains in the screen memory. Memory location 0 is overwritten, however, with new data

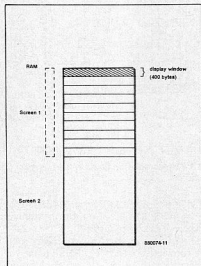

Fig. 2. Each screen memory of 4 Kbytes is subdivided in ten windows of 400 bytes.

when the screen memory is full. Scrolling per line or per screen is simple to effect by incrementing the cursor start address in steps of 8 or 50, respectively, assuming that the LC screen is programmed to display 8 lines of 50 characters.

In graphics mode, 50 bytes are required for 400 dots horizontally. The vertical resolution is 64 dots, so that one graphics screen corresponds to  $50 \times 64 = 3200$  bytes. This means that the screen memory (4 Kbyte) can hold one graphics screen with 896 bytes left. The controller used in the interface circuit is a relatively complex chip. It has a built-in character ROM, and takes care of the parallel-to-serial conversion of the data provided by the computer interface circuit. When an (optional) external EPROM is added, the user has a choice of three character fonts.

The last block in Fig. 1 is the contrast control circuit. A discrete 4-bit DAC is driven via a register, and provides a 16-level contrast setting. The directly addressable register is also used for switching between the two 4 Kbyte screen memories, and the two EPROM-resident fonts, which are optional.

## Circuit description

The complexity of the circuit shown in Fig. 3 is only apparent, and caused mainly by the ability of the interface to be driven by various types of computer. Connector K<sub>1</sub> links the computer's CPU to the LC screen interface. Circuits IC<sub>6</sub> and IC<sub>7</sub>, together with 8-way DIL switch blocks, form a presettable 16-bit address decoder for mapping the card in the computer's memory. When the bit pattern set by means of the DIL switches matches that on the address bus, output  $\bar{P}=\bar{Q}$  goes low. The least significant three address lines are not connected to the address decoder, and appear as X<sub>0</sub>, X<sub>1</sub> and X<sub>2</sub> on the internal bus of the interface. This arrangement allows the combining of system-dependent signals with the address decoding. In the case of the IBM PC, for instance, X<sub>0</sub> carries signal AEN. Similarly, with MSX systems, X<sub>2</sub> carries IOREQ, and X<sub>0</sub> bus signal M<sub>1</sub> (X<sub>1</sub> is not used, jumper R is not fitted). The interface occupies 8 memory locations, 5 of which are used for addressing registers — see Table 1. Circuit IC<sub>5</sub> functions as a bidirectional databus buffer. Together with IC<sub>1</sub>, a decoder for internal signals, it is enabled when the interface is selected via the computer's address bus. Gates N<sub>1</sub> to N<sub>6</sub> convert and combine the control signals provided by the microprocessor bus. Table 2 provides bus connection information, and lists the configuration of jumpers A to T, in accordance with the computer system used.

Interface output WAIT is provided to

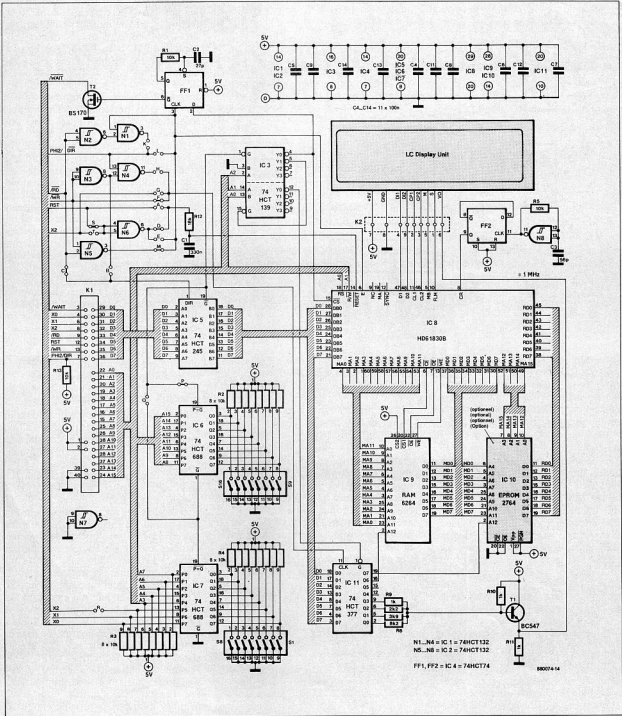

Fig. 3. Circuit diagram of the universal interface for high-resolution liquid crystal screens. The configuration of the jumpers is in accordance with the type of computer used for driving the circuit.

ensure correct operation of the controller when this is connected to a relatively 'fast' computer bus. Bistable FF<sub>1</sub> is a monostable multivibrator which pulls WAIT low via FET T<sub>2</sub>. Its monotime is about 450 ns, as set with network R<sub>1</sub>-C<sub>1</sub>. WAIT is an open-drain line that can be connected to an existing wired-AND network as used in IBM PCs

(8088/8086) and MSX micros (Z80). Obviously, WAIT is not used in systems where it is not required. The RESET input of the controller, IC<sub>3</sub>, is connected to the CPU RESET line via a low-pass filter, R<sub>12</sub>-C<sub>1</sub>, which serves to suppress spurious pulses. Circuit IC<sub>11</sub> is the previously discussed latch for the contrast setting circuit. Its

outputs, Q<sub>0</sub> to Q<sub>3</sub>, drive the discrete DAC, R<sub>6</sub>-R<sub>9</sub>-T<sub>1</sub>. Only two of the remaining four outputs of IC<sub>11</sub> are used — Q<sub>6</sub> and Q<sub>7</sub> as the RAM as the 4 Kbyte selection lines, A<sub>12</sub>, of the screen RAM (IC<sub>9</sub>) and character EPROM (IC<sub>10</sub>) respectively. It is possible to store 4 screen fonts in EPROM by using the 16 Kbyte 27128, and one of the two remaining

outputs on IC<sub>11</sub> as the 14th address line. The clock generator for the controller chip is formed by an R-C oscillator, Ns. The actual clock frequency is not so important, but a symmetrical clock signal is a must for the HD61830B, hence the use of divide-by-two bistable FFs.

One slightly unusual connection in the interface circuit is that of input R/-W of the controller to address line A<sub>1</sub>. This solution was adopted to solve possible timing problems. Read and write levels should be available 140 ns before the enable pulse, which, in turn, should have a minimum duration of 440 ns. The connection of A<sub>1</sub> to R/-W results in differ-

ent addresses for read and write operations to the interface registers — see Table 1.

**Table 1. Data/Control Registers**

Address	A15	A2	A1	A0
DATA-WR	x	0	0	0
CTRL-WR	x	0	0	1
DATA-RD	x	0	1	0
CTRL-RD	x	0	1	1
LATCH	x	1	0	0

## Construction

The LC screen interface is constructed on a double-sided, through-plated printed circuit board (see Fig. 4). The track layout is not given here because this PCB is virtually impossible to make other than from films, while through-plating equipment is usually only available in a professional workshop. The size of the ready-made PCB is such that it can be attached to the controller board of the LM40001 unit with the aid of 4 spacers.

To be continued next month.

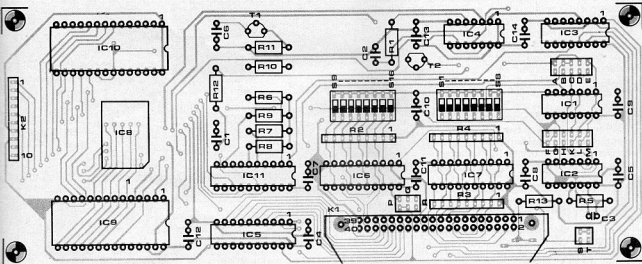

**Fig. 4. Component mounting plan of the double-sided, through-plated PCB for the LC screen interface. This high-quality PCB is available ready-made through the Readers Services.**

### Parts list

#### Resistors (±5%):

R<sub>1</sub>, R<sub>5</sub>, R<sub>13</sub> = 10K  
 R<sub>2</sub>, R<sub>3</sub>, R<sub>4</sub> = SIL resistor array 8 × 10K  
 R<sub>6</sub> = 8K2  
 R<sub>7</sub> = 3K9  
 R<sub>8</sub> = 2K2  
 R<sub>9</sub>, R<sub>10</sub>, R<sub>11</sub> = 1K0  
 R<sub>12</sub> = 18K

#### Capacitors:

C<sub>1</sub> = 330n  
 C<sub>2</sub> = 27p  
 C<sub>3</sub> = 56p  
 C<sub>4</sub>... C<sub>14</sub> incl. = 100n

#### Semiconductors:

T<sub>1</sub> = BC547B  
 T<sub>2</sub> = BS170  
 IC<sub>1</sub>, IC<sub>2</sub> = 74HCT132  
 IC<sub>3</sub> = 74CT139

IC<sub>4</sub> = 74HCT74

IC<sub>5</sub> = 74HCT245

IC<sub>6</sub>, IC<sub>7</sub> = 74HCT688

IC<sub>8</sub> = HD61830B (Hitachi)

IC<sub>9</sub> = 6264 or 8264 8K × 8 static RAM

IC<sub>10</sub> = 2764 (optional character set EPROM,

IC<sub>11</sub> = 74HCT377

#### Miscellaneous:

S<sub>1</sub>... S<sub>6</sub> incl., S<sub>7</sub>... S<sub>16</sub> incl. = 8-way DIL switch block.  
 K<sub>1</sub> = 40-way PCB header with eject handles; male; with angled pins for PCB mounting.  
 K<sub>2</sub> = 10-way SIL header.  
 PCB Type 880074  
 LC display Type LM40001

**Hitachi Electronic Components (UK) Ltd.** ● Hitec House 221-225 Station Road ● Harrow ● Middlesex HA1 2XL. Tel.: (01 861) 1414. Tlx.: 936293 hitec g. Fax: (01 863) 6646.

**Hitachi Electronic Components Europe GmbH (Headquarters).** ● Hans-Pinsel Strasse 10A ● D-8013 Haar nr. Munich. Tel.: +49 894614/0. Tlx.: 5-22593 hitc d. Fax: +49 89463151.

**Sharp Electronics (UK) Ltd.** ● Sharp House ● Thorp Road ● MANCHESTER M10 9BE. Tel. (061 205) 2333. Fax: 061 205 7076.

# SIMPLIFIED TIME-SIGNAL RECEIVER

The automatic synchronization facility of many microprocessor-based clocks ensures reasonable long-term accuracy even when the relevant time-signal transmitter is received for only a couple of minutes each day. Obviously, this feature relaxes the design requirements of the receiver, which can be kept relatively simple. Such a receiver is described here: it has a digital pulse output, excellent sensitivity, and can be tuned to time-standard stations transmitting in the VLF band between 50 and about 100 kHz.

Time-signal transmitters such as Rugby MSF, HBF and DCF77 operate in the VLF (very low frequency) band, at frequencies between 50 and 100 kHz. The VLF band is characterized by very predictable propagation characteristics, but received signals often suffer from interference generated by electrical apparatus such as TV sets and dimmers. The receiver should, therefore, have good or very good selectivity. The frequency conversion principle (heterodyne receiver) must be dismissed, however, when the practical design is to remain as simple as possible.

## Circuit description

Selectivity of the present VLF receiver is determined solely by the aerial and two tuned circuits. High-gain RF amplifiers are used, and a special, non-linear, demodulator extracts the time signals from the still relatively noisy RF input signal.

The circuit diagram of Fig. 1 shows that the RF signal from the transmitter is picked up by an active aerial circuit, whose output signal is filtered by tuned circuit L<sub>1</sub>-C<sub>1</sub>, and amplified by dual-gate MOSFET T<sub>1</sub>. A further tuned circuit inserted in the drain line of this transistor ensures adequate receiver selectivity. The drain signal is rectified by D<sub>1</sub> to provide automatic gain control (AGC) on gate 1 of the MOSFET. The AGC has a relatively slow response because fading is generally slow on VLF.

Circuit IC<sub>1</sub> is a Type SO42P balanced mixer/oscillator from Siemens. In the present application, it functions as a four-quadrant multiplier, so that its output signal is proportional to the square of the input signal provided by T<sub>1</sub>. The modulation frequency on DCF77 is relatively low, so that a single R-C network, R<sub>3</sub>-C<sub>3</sub>, is sufficient for removing the RF component from the rectified time signals. These are filtered and shaped in a further (active) rectifier, IC<sub>2</sub>, whose output signal is a measure of the instan-

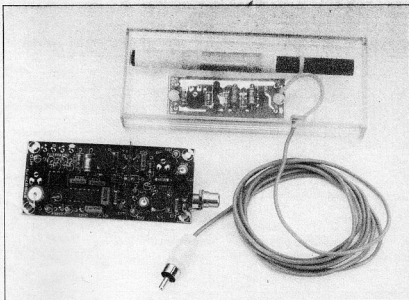

Completed prototype of the simplified time signal receiver, connected to the associated active aerial.

taneous amplitude of the time signals. The discharge time of C<sub>16</sub> is relatively long (P<sub>2</sub>-R<sub>10</sub>), so that the voltage on this capacitor is largely constant for the duration of the time pulses. Comparator IC<sub>2</sub> compares the instantaneous amplitude of the rectified voltage to a part of the absolute amplitude, set with P<sub>2</sub>. The output of the receiver supplies time pulses as they are modulated, i.e., a time pulse corresponds to a logic low level. This makes the present time signal receiver compatible with the Intelligent Time Standard published in Ref. (12), but only if DCF77 is being received.

The circuit diagram shows the capacitor values needed for reception of DCF77 on 77.5 kHz. The tuned circuits can be modified for reception of, for instance, Rugby MSF at 60 kHz, by multiplying the value of C<sub>2</sub>, C<sub>7</sub> and C<sub>8</sub> by a factor  $(77.5/60)^2 \approx 1.67$ , and using the closest practical capacitor value.

## Construction and alignment

The receiver is composed of two boards: active aerial and receiver/demodulator. The active aerial is identical to that used for the DCF77 receiver and locked frequency standard (see Ref. (1)). The unit is constructed on the small printed circuit board shown in Fig. 2. The aerial, L<sub>5</sub>, is formed by about 200 closewound turns of 0.2 mm dia. enamelled copper wire on a 30 mm long cardboard or paxolin former. This is slid on to a 12-20 cm long ferrite rod of 10 mm diameter. The rod and associated former used for building the prototype receiver were parts salvaged from a discarded MW/LW radio.

Populating the receiver/demodulator board shown in Fig. 3 should not present problems. A 15 mm high tin plate or brass screen is fitted across T<sub>1</sub> as shown

on the component overlay. The screen has small clearances for T<sub>1</sub> and R<sub>3</sub>, and is secured to the PCB with the aid of two soldering terminals. Note that a number of parts are fitted upright.

Use one metre or so of screened microphone wire to connect the active aerial to the main receiver board.

First, concentrate on setting up the active aerial. Power up and check the DC settings at the points indicated in the circuit diagram. Set a sine-wave generator to the receiving frequency (e.g., 77.5 kHz), and connect a coupling loop and a series resistor to the output of the instrument. Wind the coupling loop on to the ferrite rod, and connect an AC-coupled oscilloscope to the output of the active aerial. Slide the former until the

signal amplitude is a maximum. Reduce the output of the generator, and move the coupling loop away from the rod.

Again slide the former on the rod to find the resonance point. If this is found with the former partially off the rod, the number of turns of L<sub>1</sub> should be reduced. Experiment with the value of C<sub>41</sub> and the setting of P<sub>2</sub> until the completed active aerial has a selectivity of about 10 kHz, and the former is about flush on the rod. When this cannot be achieved, the ferrite rod may have incorrect RF properties, and there is no alternative but to try out another type. After adjustment, the former is secured on the ferrite rod by means of wax or sellotape. Do not use a metal support for fixing the rod.

Switch off the generator, increase the sensitivity of the scope, and rotate the rod in the horizontal plane until the RF signal from the time signal station is observed on the oscilloscope screen. The signal is relatively small, but should have an amplitude between 5 and 50 mV<sub>pp</sub>. Connect the probe to the drain of T<sub>1</sub>, and carefully peak L<sub>1</sub> and L<sub>2</sub> for maximum amplitude. If clipping or oscillation occurs, reduce the gain of T<sub>1</sub> by adjusting P<sub>1</sub>. Readjust the active aerial and the tuned circuits with a high-impedance voltmeter connected to pin 2 of IC<sub>1</sub>.

The time signals can be heard on high-impedance (600 Ω) headphones connected between the positive supply and test point TP2. Finally, mount the active aerial in a position well away from

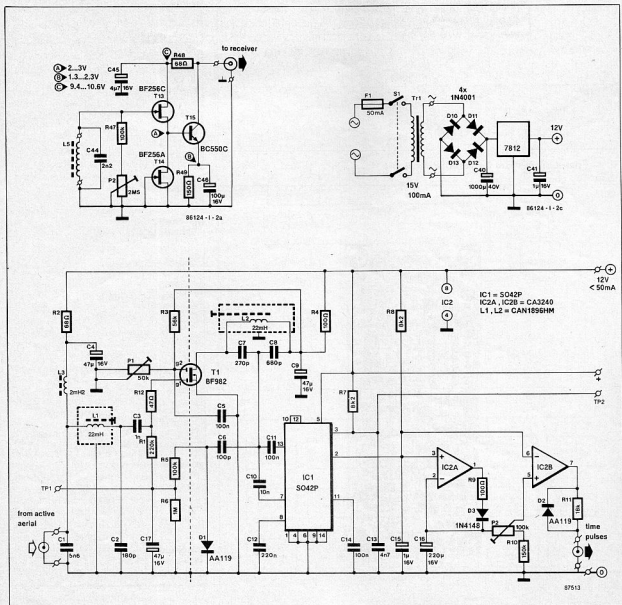

Fig. 1. Circuit diagram of the VLF time signal receiver.

sources of interference. The length of the screened cable between the active aerial and the main receiver board should not exceed 15 m or so.

#### References:

- (1) DCF77 receiver and locked frequency standard. *Elektor India*, February 1988.
- (2) Intelligent time standard. *Elektor India*, March 1988.

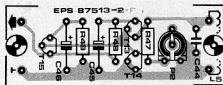

Fig. 2. Printed circuit board for the active aerial.

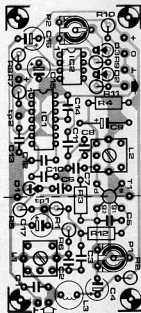

Fig. 3. Printed circuit board for the time signal receiver/demodulator.

#### Parts list

##### ACTIVE AERIAL:

##### Resistors ( $\pm 5\%$ ):

R47 = 100K  
R48 = 68R  
R49 = 150R P2 = 2M5 preset H

##### Capacitors:

C44 = 2n2  
C45 = 4 $\mu$ 7; 16 V; radial  
C46 = 100 $\mu$ ; 16 V; radial

##### Semiconductors:

T13 = BF256C (Cricklewood)  
T14 = BF256A (Cricklewood)  
T15 = BC550C

##### Inductor:

L5 = see text. Ferrite rod: e.g. Cirkit Type FRA (stock number 35-14147).

##### Miscellaneous:

PCB Type 87513-2

##### MAIN RECEIVER BOARD:

##### Resistors ( $\pm 5\%$ ):

R1 = 220K  
R2 = 68R  
R3 = 56K  
R4; R9 = 100R  
R5 = 100K  
R6 = 1M0  
R7; R8 = 8K2  
R10 = 150K  
R11 = 18K  
R12 = 47R  
P1 = 50K preset H  
P2 = 100K preset H

##### Capacitors:

C1 = 5n6  
C2 = 180p  
C3 = 1n0  
C4; C17 = 47 $\mu$ ; 16 V; radial  
C5; C11; C14 = 100n  
C6 = 100p  
C7 = 270p  
C8 = 680p  
C9 = 47 $\mu$ ; 16 V; axial  
C10 = 10n  
C12 = 220n  
C13 = 4n7  
C15 = 1 $\mu$ 0; 16 V; radial  
C16 = 220 $\mu$ ; 16 V; radial

##### Inductors:

L1; L2 = 22mH variable; Toko 10PA series, Type CAN1896HM (Cirkit stock number 35-18960).  
L3 = 2mH2 radial choke; Toko Type 181LY-222 (Cirkit stock number 34-22202).

##### Semiconductors:

D1; D2 = AA118  
D3 = 1N4148  
T1 = BF982 (C-I Electronics)  
IC1 = SO42P (Bonex; C-I Electronics; Universal Semiconductor Devices Ltd.)  
IC2 = CA3240

##### Miscellaneous:

PCB Type 87513-1

# A MICROPROCESSOR-BASED INTELLIGENT MULTI-FUNCTION TEST INSTRUMENT

by Dr. D.P. Mital

School of Electrical and Electronic Engineering, Nanyang Technological Institute, Singapore.

A high precision, intelligent, test instrument is described that offers ten measuring functions: DC and AC voltages, DC and AC current, resistance, capacitance, frequency, digital counter, data logging and phase measurements. The system is intelligent enough to automatically range itself for proper measurements, and is capable of providing statistical functions such as calculation of mean and standard deviations, which are useful for low-frequency measurements.

The researcher or technician involved in project development usually requires many instruments to perform various common measurements. Often, a lot of precious time is wasted in connecting and disconnecting these instruments. Also, handling and storage problems soon arise in the work area as the number of instruments increases.

Recently, there has been considerable interest in integrating many functions in one compact unit (Ref. <sup>(1)</sup>, <sup>(2)</sup>). The industry has been very receptive to this idea. This article presents a multifunction unit which has some intelligence, and integrates many common measuring functions. Accuracy, reliability and low cost are also important considerations. The proposed system is developed around the Type 8086 16-bit microprocessor from Intel, and is capable of performing operations which include that of a common multimeter, capacitance meter, phase meter, frequency meter, digital counter and data logger. Autoranging and repetitive modes for averaging are also available. The measuring function and, optionally, the range, is selected by means of a 16-key membrane keyboard, and measurement results are sent to a 40-character LC display. Since the system has intelligence, on-line data and results may be stored semi-permanently, and retrieved when required. This feature makes the system highly suitable for real-time interactive measurement and control applications. A multiple number of readings can also be recorded in a fixed time interval.

For reasons of speed and efficiency, the system software has been written in 8086 assembly language. The software was written and debugged using an IBM PC/AT and an HP6400 development system.

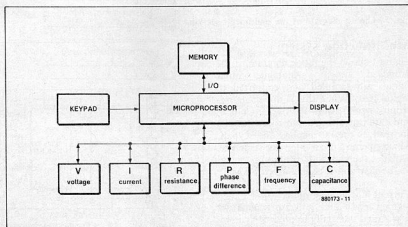

Fig. 1. Block diagram of the multifunction test instrument.

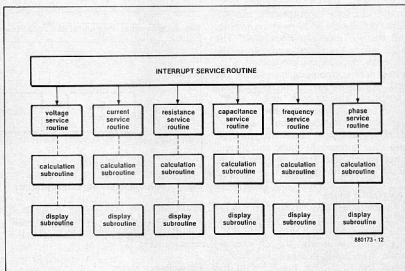

Fig. 2. General structure of the system software.

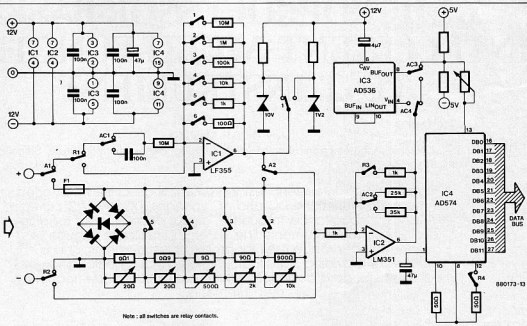

Fig. 3. Circuit diagram of the multimeter section.

## Multifunction system

Figure 1 shows the block diagram of the proposed system. Analogue input signals are sampled and converted to digital data. When this is done, the microprocessor strobes the relevant block, and data processing commences. Results are read on the LC display. The keypad, which operates in an interrupt structure, provides the user with minimum control of the instrument as explained above.

## Current and voltage meter

Signals for V and I measurements are first scaled internally to prevent their exceeding the maximum input specification of the A-D converter ( $\pm 5$  V). After scaling, the DC signal is fed direct to the sampling circuit, while the AC signal is fed to an RMS-to-DC converter, and then to the sampling circuit. The ADC awaits the strobe signal from the microprocessor to start conversion. Converted data is immediately read via the data bus. A two-pole, microprocessor-controlled, change-over switch selects the appropriate measurement function. Signals exceeding 200 mV are attenuated, and later amplified to TTL level. The ranges for voltage and current measurements are 20 mV to 1000 V and 20  $\mu$ A to 2 A respectively.

## Resistance meter

For resistance measurement, two voltage references are used. This is done to extend the measurement range. One reference voltage is used in the autoranging mode. The resistance sampling circuit shares the first stage opamp with the voltage sampling circuit. The output voltage of the comparison block is pro-

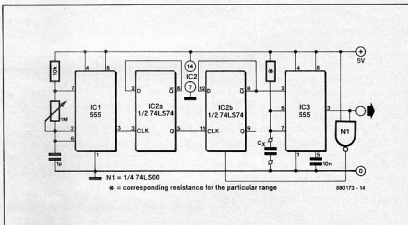

Fig. 4. Schematic diagram of the capacitance meter section.

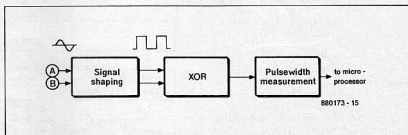

Fig. 5. Block diagram of the phase meter.

portional to the unknown resistance, for which six ranges are available. The circuit diagram of the multimeter section is shown in Fig. 3.

## Capacitance meter

Capacitance measurement is based on pulse-width modulation techniques.

Again, six ranges are provided. The basic circuit diagram of Fig. 4 shows that the charging and discharging properties of capacitors are used to determine capacitance with the aid of two timers Type 555, and two bistables. The timers are configured to function as monostable multivibrators.



### Phase meter

Phase detection first requires the conversion of sinusoidal input signals to rectangular waves as shown in the block diagram of Fig. 5. The phase difference between the input signals can be computed by the CPU because it is proportional to the pulse-width of the signal supplied by the XOR gate.

### Frequency meter

Frequency measurement is similar to phase detection. The block diagram of Fig. 6 shows that the input signal is made rectangular before being applied to a combinational circuit and a programmable divider. These two circuits control a 32-bit counter. The divider, which is initially set to a factor of  $\div 2$ , stops the counter on the rising edge of the second pulse. This completes the first phase of the measurement. The CPU calculates the period and estimates the number of pulses needed from the input signal for 0.1 s of sampling time. The divider is then programmed accordingly. The count procedure is similar for the second sample of the input signal, but this time the counter stops after a known number of pulses, as determined by the CPU and executed by the divider. The measurement principle adopted allows signal frequencies to be determined with high precision.

### Event counter

Event measurement is essentially similar to that for frequency, and shares a part of the relevant circuitry. Only counter start and stop signals are needed, which are provided by the measuring circuit.

### Data logger

Data logging is purely a software function. Displayed data is stored in memory when the STROBE key is actuated on the keypad. Key RECALL may be pressed for data to appear on data lines and on the LC display. The system is capable of storing hundreds of data readings sequentially. Last-in data can be recalled first (LIFO stack). The flowchart of the data logger function is given in Fig. 7.

### Software development

The following description is intended to give a basic idea of the operation of the control software for the instrument. It is assumed that this is set to capacitance measurement. Pressing the CAPACITANCE key causes the interrupt servicing routine to be activated. After the interrupt source is determined, the service routine passes control to the capacitance measurement program, which arranges the necessary switching and sampling of data. Repetitive reading may be used for calculation of mean and standard deviations. The calculation routine is called to process the available data, followed by the display routine to provide legible results.

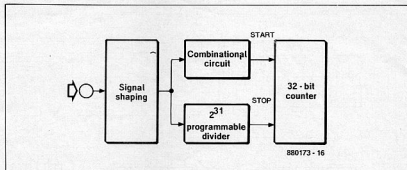

Fig. 7. Flowchart of the data logging routine

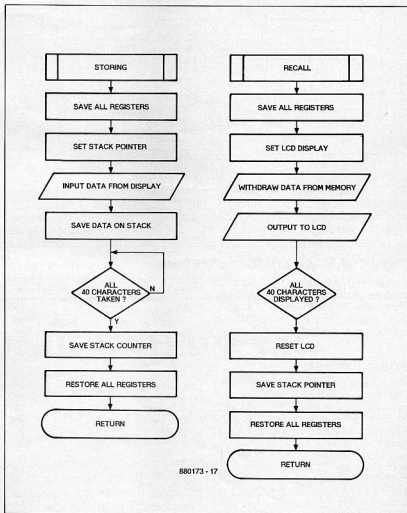

Fig. 6. Block diagram of the frequency meter.

Every measuring function has a control program, which is called up by pressing the appropriate key. Control programs perform the necessary switching in the measurement circuits, and manipulate available data. First, the range flag is checked, and the hardware is controlled accordingly by autoranging software to ensure optimum accuracy before data is accepted. The control software is also involved in the repetitive mode of oper-

ation. A simplified flowchart of the control programs is shown in Fig. 8. Autoranging is not used during measurement of frequency and phase, since in these modes data samples are taken twice: first for estimating the order of magnitude, and then for the actual measurement. The flowchart of the frequency control program is given in Fig. 9.

The operation of the test instrument is

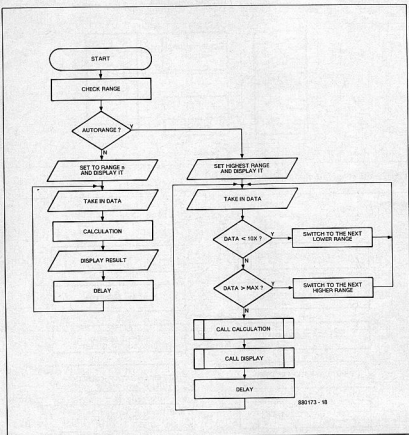

Fig. 8. General flowchart of the control programs.

further co-ordinated by software modules written for each function. These modules each consist of a function service routine, a calculation routine and a display routine.

### System hardware

The wiring diagram of Fig. 10 shows that the hardware of the CPU card basically consists of a 8086 CPU with 64 Kbyte of memory (RAMs and EPROMs), buffers (74LS245 and 8286), latches (74LS373 and 8282) and decoders (74LS138). A total of 64 I/O ports is used. These are addressable from 00H to 3FH as shown in Table 1. The 4x4 key membrane keypad utilizes a Type 74C922 encoder. The 1 line x 40 character LC display is of the dot-matrix type. It is connected to data I/O lines DB0-DB15 through 74LS245 buffers, which form port numbers 10H and 11H.

### Experimental results and conclusion

Results of all measuring functions of the instrument were compared with existing, high-precision, laboratory equipment. In all cases, deviations from the standard equipment remained well within 2%. Phase, frequency and event count

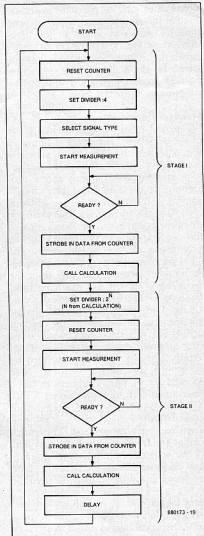

Fig. 9. Flowchart of the frequency measurement program.

measurements were on average within 0.5% accuracy. Table 2 shows the results of a few comparative measurements taken with the proposed multifunction instrument.

The author believes that it is worthwhile to spend time on further development of the multifunction instrument, whose basic lay-out has been discussed here. The design of the instrument shows that test & measurement equipment is heading in the same direction as much other electronics equipment, i.e., towards high-level integration.

Table 1. Port addresses

	Port addresses
V/I/R BOARD	00-0F
A-D data input	00
status check	01
A-D control	02
Range control	04
Function control	06
FREQUENCY BOARD	08-0F
Counter setting	08
Divider setting	09
Ready input	0A
Start output	0C
Counter data input	0E
CAPACITANCE & PERIPHERAL BOARD	10-17
Display control	10
Display data	11
Input data	12
C range control	14

All addresses in hexadecimal.

Table 2. Experimental results							
Voltage		Current		Resistance		Capacitance	
Standard	Measured	Standard	Measured	Standard	Measured	Standard	Measured
5 V	4.98 V	4.8 V	4.68 V	1.5 kΩ	1.506 kΩ	10 pF	10 pF
50 V	49.44 V	12 V	11.92 V	10 kΩ	10.04 kΩ	1000 pF	1001 pF
120 V	119.12 V	50 V	48.81 V	47 kΩ	47.02 kΩ	0.1 μF	0.099 μF

For AC measurements RMS values are recorded.

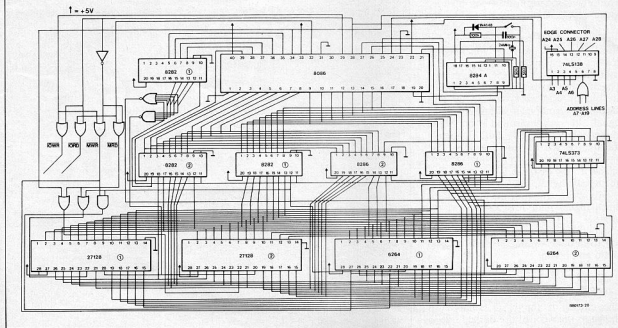

Fig. 10. Wiring diagram of the microprocessor board in the multifunction instrument.

#### Acknowledgements:

the author would like to thank Mr Bay Way Yee and Miss Chong Mong Tan for developing and testing the system, and professor Brian Lee, Dean of the School of Electrical and Electronic Engineering, for providing facilities for carrying out this work.

#### References:

- (1) Trautman J. and Desjardin L.: *A portable low-cost high performance digital multimeter*. HP Journal, Vol. 34, no. 2, 1983.
- (2) Steever S. et al.: *Seven-function systems multimeter offers extended resolution and scanner capabilities*. HP

Journal, Vol. 37, no. 2, 1986.

(3) Walter A. and Singh A.: *The 8086 Microprocessor Architecture, software and interfacing techniques*. Prentice-Hall, 1986.

(4) *Macro assembler*. (IBM personal computer language series) Microsoft, 1985.

## HARMONIC ENHANCER

by W. Teder

An harmonic enhancer, or exciter, generates harmonics from, and superimposes these on to, a music signal that has none, or few, of these overtones. In that sense, it is a sound-correcting device that adds warmth to a sound.

The principle of the operation of an exciter is shown in Fig. 2. Part of the original signal is fed to a variable clipper, whose cut-off frequency can be set from 1-5 kHz. The filter output, whose amplitude should not exceed 10% of that of the original signal, is then recombined with the original signal.

The basic set-up in Fig. 2 may be modified and refined in various ways. It is, for instance, possible to make several of the filter parameters adjustable externally, but for most relatively simple needs this sophisticated approach is not really necessary. Moreover, the filter might be preceded by a compressor circuit

and followed by an expander circuit. This method obviates the serious distortion caused by short signal peaks and also ensures that the harmonic content does not vary too greatly with the input level. Whatever refinements or modifications are introduced, they lead to a unit with many operational possibilities,

all of which have to be set up carefully. The enhancer described here is intended as an experimental unit for use by the constructor to become acquainted with the basics of the harmonic enrichment effect. None the less, the unit may, of course, be expanded as required at a later date.

The harmonics caused by the clipping are mainly odd-order ones. After they have been recombined with the original signal, the resulting sound is only little louder (about +1 dB), but, as already stated, it is warmer, more mellow. The new sound may, however, just be distorted if, for instance, the cut-off frequency of the clipper is set low, i.e., at 1 kHz, and the level of the harmonics is much higher than 10% of that of the original signal. Used with electric guitars, this may not be unacceptable, but it certainly would be with a good audio amplifier.

### Circuit description

The circuit of the basic enhancer is shown to the right of the dashed line in Fig. 3. It is based on two integrated circuits, IC<sub>1</sub> and IC<sub>2</sub>.

The signal is applied to low-noise amplifier IC<sub>1</sub> via C<sub>1</sub> and R<sub>1</sub>, which form a high-pass section with a cut-off frequency of 2.4 kHz. Further attenuation of frequencies below 1 kHz is provided by high-pass section R<sub>3</sub>-C<sub>3</sub>.

After amplification (gain is set by P<sub>1</sub>), the high-frequency part of the signal is clipped asymmetrically by R<sub>5</sub>-D<sub>1</sub>. The distorted (i.e., rich in harmonics) signal is applied to the inverting input of IC<sub>2</sub> via P<sub>2</sub> and a further low-pass section, R<sub>7</sub>-C<sub>4</sub>. The effect signal may be switched off by S<sub>1</sub>.

Also applied to the inverting input of IC<sub>2</sub> is the original signal (via R<sub>4</sub>).

Since a too high amplification of the effect signal leads to audible distortion, a peak meter has been added. This consists of opamps A<sub>1</sub> and A<sub>2</sub>, which form a window discriminator, and T<sub>4</sub>. The reference voltages for the window (pins 3 and 6 of IC<sub>2</sub>) are derived from divider R<sub>10</sub>-R<sub>12</sub>-R<sub>13</sub>. The output voltage of IC<sub>1</sub> is monitored via R<sub>30</sub>. If this lies outside the window potentials, capacitor C<sub>7</sub> is charged via R<sub>15</sub> and transistor T<sub>1</sub> switches on peak warning light D<sub>4</sub>. Capacitor C<sub>8</sub> in the collector circuit of T<sub>4</sub> extends the operation of D<sub>4</sub>, so that even short peaks are indicated. The setting of P<sub>1</sub> is optimum when D<sub>4</sub> flickers during signal peaks.

The cut-off points of high-pass sections R<sub>1</sub>-C<sub>1</sub> and R<sub>3</sub>-C<sub>3</sub> have been determined empirically with the aid of an electric guitar.

The harmonic content can be controlled satisfactorily when the unit is used with an electric guitar. If the enhancer is for use with hi-fi or PA equipment, the

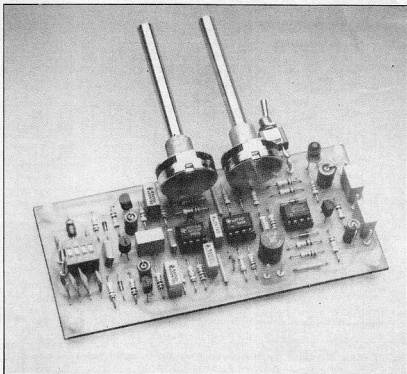

Fig. 1. General view of the Harmonic Enhancer.

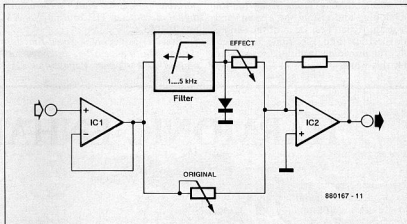

Fig. 2. Block schematic of the Harmonic Enhancer.

values of C<sub>1</sub>, C<sub>3</sub> and C<sub>4</sub> should be halved. It is, of course, also possible to experiment with a high-order variable filter at the input circuit of IC<sub>1</sub>.

If the threshold of operation of D<sub>4</sub> is found too high, the value of R<sub>12</sub> may be reduced as required. This is conveniently done with a 500-ohm potentiometer in series with a 470-ohm fixed resistor.

If the enhancer is intended for use as a guitar effects unit, the amplifier to the left of the dashed line in Fig. 3 is recommended. Strictly speaking, this is an impedance inverter, based on a FET, which has been designed specifically for

**Semiconductors:**  
 D<sub>1</sub>;D<sub>2</sub>;D<sub>3</sub>;D<sub>5</sub>;D<sub>6</sub> = 1N4148  
 D<sub>4</sub> = red LED  
 T<sub>1</sub> = BC284A\* (Philips Components)  
 T<sub>2</sub> = BC550C  
 T<sub>3</sub> = BC560C  
 T<sub>4</sub> = BC547B  
 IC<sub>1</sub> = NE5534P  
 IC<sub>2</sub> = TL071CP  
 IC<sub>3</sub> = TL072CP

\* Listed by Cricklewood Electronics.

**Miscellaneous:**  
 L<sub>1</sub> = max. 1mH0 (see text)  
 S<sub>1</sub> = miniature SPST switch. S<sub>2</sub> = 4-way DIL switch block.  
 PCB Type 880167

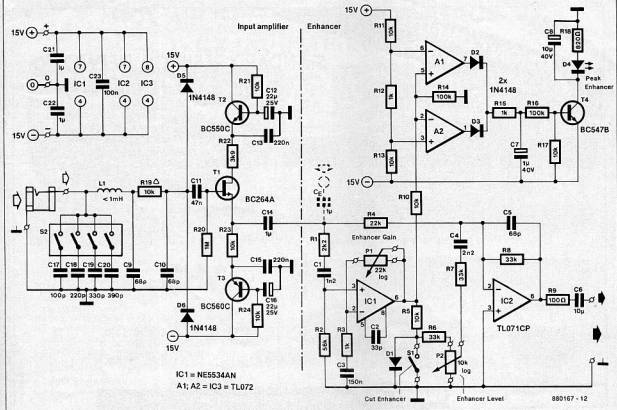

Fig. 3. Circuit diagram of the enhancer (to the right of the dashed line), and the impedance inverter for use with guitars.

use with a guitar pick-up.

The input consists of two low-pass sections,  $L_9$ - $C_9$  and  $R_{19}$ - $C_{10}$ , which effectively prevent interference from HF equipment. In a non-critical environment,  $L_9$ - $C_9$  may be omitted.

Diodes  $D_5$  and  $D_6$  protect the input against too high voltages.

The signal is taken from the low-impedance source of  $T_1$  and applied to the enhancer via  $C_{14}$ .

The circuits around  $T_2$  and  $T_3$  provide further smoothing and filtering of the power supply lines.

DIP switch  $S_2$  facilitates matching to various cable lengths, which, of course, is a boon for many musicians. With values of capacitors  $C_{17}$  to  $C_{20}$  as shown, cable lengths of 1 to 10 m may be accommodated.

## Finally

The enhancer and input amplifier for guitars may be conveniently constructed on the PCB shown in Fig. 4.

Although the circuit shows a mains-operated power supply, a  $\pm 9$  V battery supply may also be used if only the enhancer and input amplifier are used. Rechargeable 9 V batteries will give about 6 hours continuous use, while two PP9 batteries will give about 25 hours. It should, however, be borne in mind that in view of the supply current of around 20 mA it is advantageous to use a mains supply. This is even more so if other modifications are incorporated.

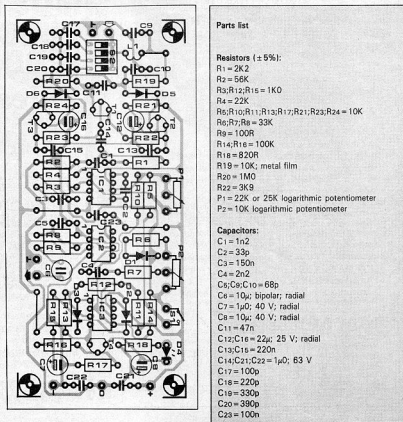

## Programmer Controller

JELTRON Model 814A Programmer Controller is a self contained microprocessor based set point programmer and a single loop industrial controller combined in one compact case. The 814A accepts directly process variable inputs from TCs, RTDs, transmitter voltages and currents and Optical Radiation Temperature Detectors. All temperature inputs are linearized and direct reading in degrees F or C, switch selectable. All transmitter units are field configurable in engineering units, from 999 to 9999 with full decimal point positioning. All program parameters such as Range Limits, Set points, Ramp Times and Soak Times are entered in full engineering units. Times are user configurable from 0.0 to 99.9 hours or minutes. The 814A is a single channel instrument that can store a maximum of 30 segments. Individual programs can be fully independent or linked. A loop instruction allows the segment or any combination of segments to be repeated upto 99 times. Complete program configuration is stored in solid state non volatile EAROM. The 814A is available in wide choice of Control outputs. Reverse acting or direct acting control action is switch selectable. Integral Auto/Manual Station standard with bumpless transfer from auto manual. Remote/Local set point operation is standard. The remote set point input is automatically scaled to the field configured range of the controller. Optionally, RS-232C or RS 422 communication interface is available for supervisory control applications. Set Point, Control output and Configuration of parameters are viewed using the main display. Segment number as well as Set Point are continuously displayed. Program security is assured using a front key lock.

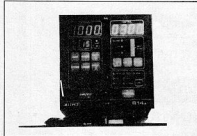

Jeltron Instruments (India) Private Limited. • 6-3-198/2, Road No. 1 • Banjara Hills • Hyderabad-500 034.

## Temperature Indicator Controller

HOSHAKUN has developed Digital Temperature with double thumbwheel type Digital Controller. It is a rugged, compact panel mountable instrument. The bright red 12.5 mm LED Display enables one to read the temperature from a long distance. Set temperature is all the time visible on the front panel by the use of thumbwheel switches. Broken sensor protection and automatic cold junction compensation is standard feature for thermocouple input. Most of the assemblies used in this instrument are plug in which offers simplicity in assembly as well as dismantling for servicing purpose. This instrument can be used for furnaces having heaters in delta/star connection such that during the start up the furnace is heated with heaters in delta form upto a certain temperature (set low) and after than it gets connected into star form up set high around which control action will take place. In other words during start up, furnace is in "MORE HEAT" mode and after exceeding first control point it goes into "LESS HEAT" mode which then controls the temperature of the furnace around the second control point. This also can be used for oil fired furnaces (MORE HEAT mode equivalent to both main and pilot burners on and less heat mode equivalent to only pilot burner on and main burner off).



HOSHAKUN • Vivek Apartments • Plot No. 15 • Tulshibagwale Colony • Sahakarnagar No. 2 • PUNE-411 009.

## Programmable Batch Counter Controller

Micronix offers an ideal instrument for applications where counting, controlling and sequencing operations are involved. The Unit is based on 8085 microprocessor with battery backed memory to retain data during power failures.

The front panel consists of an interactive 4 digit display and hermetically sealed membrane keyboard for entry of parameters. The display is used to indicate event count as well as Jobs done depending on the selected mode. It also indicates the system status on LED indicators. The number of counts per sequence is 999 and no. of sequences is 8 both expandable as per user request. The unit accepts a variety of inputs such as microswitch, optical or proximity switch etc. It provides a change over contact for controller action.

The unit works on 230VAC and is housed in DIN standard enclosure suitable for panel mounting or bench top models.

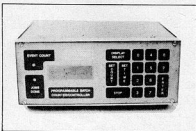

Micromix • D-74, Angol Industrial Estate • Udyambag • Belgaum-590 008, Karnataka State.

## New Open-Type Terminal Connectors

"IEC" has introduced a new range of Open Type Terminal Connectors - TBM Series. They are presently available in 12 ways, 10 ways and 8 ways. The Connectors are rated at 15 Amps, 250 V AC with an insulation resistance of more than 1000 Mohms and can withstand H.V. test of 2000 V for 1 minute. The Terminals are of Brass with Nickel plating and the housing of electrical grade bakelite or melamine on order.

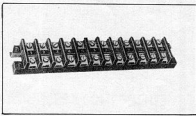

M/s. Asia Electric Company • Katara Mansion • 132A, DR. A. Besant Road • Worli Naka • Bombay-400 018.

## NEW PRODUCTS

### Dual Counter

JACSTECH, has recently developed a DUAL COUNTER for use as position encoder/indicators.

It contains two separate 4 digit counters, 2 reset sensors, and 2 separate encoder sensors. The sensors are based on infrared LEDs and Phototransistors. A slotted disc rotation in the encoder sensor field is sensed for direction and the counter is incremented by clockwise rotation and decremented by counter clockwise rotation or vice versa. Both the counters are independent in function. The counter can work to an input frequency of 15 KHz. The approximate dimension / of the card is 100 mm x 110 mm.

The system can be used for Lathe machines, displacement benches, industrial cameras, paper cutting machines, printing machines, textile machines etc.

These switches are available in the 2-wire DC version with sensing range from 5 to 25 mm. They are fully encapsulated in cylindrical chrome-plated threaded brass housings. Two lock nuts are provided for mounting and adjustment.

These switches are recommended for use in: Coal Mines, Petroleum Refineries, Fertiliser Plants, Chemical Plants etc.

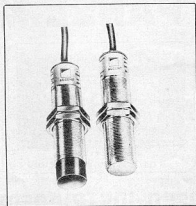

M/s. Accent Controls (P) Limited • Post Box No : 16596 • Worli Naka • Bombay-400 018.

### 1200 BPS Modems

SYSTEMS AIDS, an Electronic Equipment manufacturer in Bangalore, has indigenously developed Stand Alone Modem (SAM 1200 A) and IBM PC Compatible Internal Modems (SAM 1200 B) which combine speed and simplicity to transfer voluminous data over long distances economically. These Modems operate at 0 - 300 and 1200 bps in the asynchronous mode over PSTN and 2 wire leased lines and are full-duplex which enable them to send and receive data simultaneously. They also have a voice/data transmission capability which allows transmission of a data file and switching over to voice capability to discuss and analyse the information - all with a single phone connection.

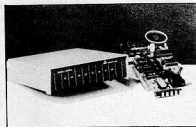

The Modems conform to CCITT V. 21 / V.22 Standard.

These Modems can be used in organisations that need to link up their computers for exchanging information and can find extensive use in Airlines, Hotels, Stock Exchanges, New Paper Officers, Banks, Business Houses, Industries or Government Departments.

M/s. Systems Aids • 80, Feet Road • (Opp. Deccan Studios) • Indiranagar • Bangalore-560 038.

### PLA DM-20A

The PLA DM-20A 4 1/2 digit Multimeter has a LCD display with resolution of 10 uV on 200 mV range in both AC & DC model. Its basic accuracy is 0.1%. Maximum voltage measurable in DC range is 1000V & 700V RMs in AC range. It has resolution of 10 nA on 200 uA range in AC mode. It has wide frequency range of 20 KHz in AC voltage. It is a battery operated and can be easily accommodated in a briefcase for on field testing.

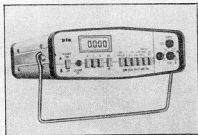

M/s. Pla Electro Appliances Pvt. Ltd. • Thakor Estate • Kurla Kirol Road • Vidyavihar (West) • Bombay-400 086.

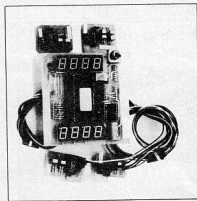

Jacstech (P) Ltd. • 117, M.G. Road, • PONDICHERRY-605 001.

### Proximity Switches for Hazardous Locations.

ACCENT has recently introduced a line of Intrinsically Safe Inductive Proximity Switches for use in hazardous locations. These are contactless limit switches and can be used to replace the conventional flameproof limit switches.

These switches feature solid state circuitry with no moving parts. Consequently, problems like roller break-age, contact bounce etc., that are common in the case of conventional limit switches, can be conveniently avoided.

## NEW PRODUCTS

### Digital Shock Meter

SHINKEN CO. LTD., of JAPAN offers v-7103, a digital acceleration meter having a charge amplifier input, a digital display with PEAK HOLD performance for vibration and shock measurements. It covers the wide frequency range of 3Hz to 20000 Hz with three high cut filters which are inevitably needed for shock measurements. Though an accelerometer (MODEL VII-101) is fitted as standard accessory, a piezoelectric force sensor may be used instead of it for shock force measurements.



**Murugappa Electronics Ltd. • Agency Division • 22 Hind Street, • Kamaraj Avenue • Adayar • Madras 600 020.**

### DIN 41612 Connectors

ERNI Elektroapparate GmbH two-piece connectors for Printed Circuit Boards confirm to international standards e.g. DIN 41612, IEC 603-2, VG95324 and to military standards, Mil-C 55302/131-134, Mil-C 55302/157-158.

Apart from the standard Euro and Reverse Euro type connectors, ERNI West

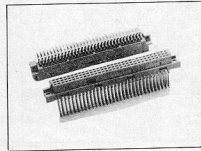

Germany can offer a wide range of special connectors and alternative wiring techniques to provide the user with the most economical solution for his particular application.

These connectors are suitable for application in telecommunication equipment, industrial control instruments, etc. Where reliability is the most important feature.

**A.T.E. Pvt. Ltd. • (Electronics Division) • 36, SDF 2, Seepz • Andheri (East) • Bombay 400 096.**

### Wire Cutting Machine

The machine gives one predetermined wire length variable from 6 cm to 60 cm. with off timing variable from 0.5 sec. to 6.0 sec. The machine can cut ordinary single core PVC flexible copper wires as well as flexible copper braided wires. It can also cut fine copper/silver wires of fixed length as per customers requirements. The machines are supplied against specific orders only.

These machines are useful in Panel Board Wiring, Fuse manufacturing, Electronic Component manufacturing etc.



**M/s. R. R. Enterprises • D-13 Nav Monica • C.S.T. Road • Opp. University Campus • Kalina • Bombay-400 098.**

### Moulded Instrument Cases DIN Standard.

G.A.M. has designed and developed Din Standard Instrument Case moulded in A.B.S. Plastic in one piece and its Casette (chassis), clamps, Front Transparent Cover, and front Bracket. It is suitable for Panel Flush mounting Instruments like Temp. Controller, Temp. Indicator, Digital Timers, or Digital Counters etc., Cases are available in two sizes:

96 X 110 mm (I.C. 110) and 96 x 96 x 150 mm (I.C.150) and in three colours Black, Light Grey and Dark Grey. It is also available in plain and with cutouts. Moulded Glass filled polyimide clamps makes case suitable for Panel Flush mountings. Transparent front cover is also available.

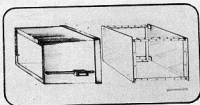

**M/s. Gaurang Auto Manufacturers • 44, Bombay Talkies Compound • Malad (W) • Bombay-400 064. • Tel: 6824159**

### Cable ties and Accessories

Cable Ties are made of high strength nylon. These ties are self locking and cannot work loose. The one piece all nylon Cable Tie can be used in virtually any bundle configuration and are available in variety of sizes either non-returnable (CP Series) or Reusable Style (CPR Series) to cover bundle diameter of 1.6 mm to 106 mm.

Each Cable tie incorporate a non-return action locking device which ensures that once in place the tie will never come off or slacken. Cable Ties can be installed easily & quickly without aid of any special tool. Available in natural colour for indoor use and also available in ultraviolet weather resistant black colour. Cable Tie mounts come to two sizes and styles to meet a wide variety of mounting applications. They are available in 3/4" and 1" square with adhesive back or 1" plain back for screw mounting. All offer 4 way insertion to speed mounting operations and the 1" Mount have a 'Cable Cradle' for added holding power.

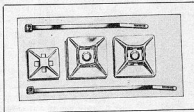

**Suresh Electronics & Electronics • 3B Camac Street • CALCUTT-700 016.**



**DO IT YOURSELF****THE****JUNIOR  
COMPUTER****BOOK****LEARN-BUILD-PROGRAM**the practical introduction  
to a powerful system

Price  
Rs. 50.00  
Available at  
all leading  
book shops.

The Junior Computer book is for anyone wishing to become familiar with microcomputers, this book gives the opportunity to build and program a personal computer at a very reasonable cost.

The Indian reprint comes to you from

**elektor** Group

Send full payment by  
M.O./I.P.O./D.D. No Cheque Please.  
Packing & Postage free

to: **elektor ELECTRONICS pvt ltd.**  
52-C, Proctor Road, Grant Road (E),  
Bombay-400 007.

